



2010 MOLDING CATALOG

19c Industry St, Poughkeepsie, NY 12603
Phone (845) 485-4105 • Fax (845) 485-4106
firstcutcustomwoodworks.com

TABLE OF CONTENT

Crown	1.1
Casings.....	2.1
Base Molding.....	3.1
Base Caps	4.1
Chair Rails	5.1
Stops, Panels & Picture Molding, Canvas Stretchers	7.1
Coves, Rounds & Beads.....	8.1
Astragals & Mullions	9.1
Window Stools	10.1
Flooring, Wainscoting, Paneling, S4S	11.1
Rosettes & Plinth Blocks	12.1



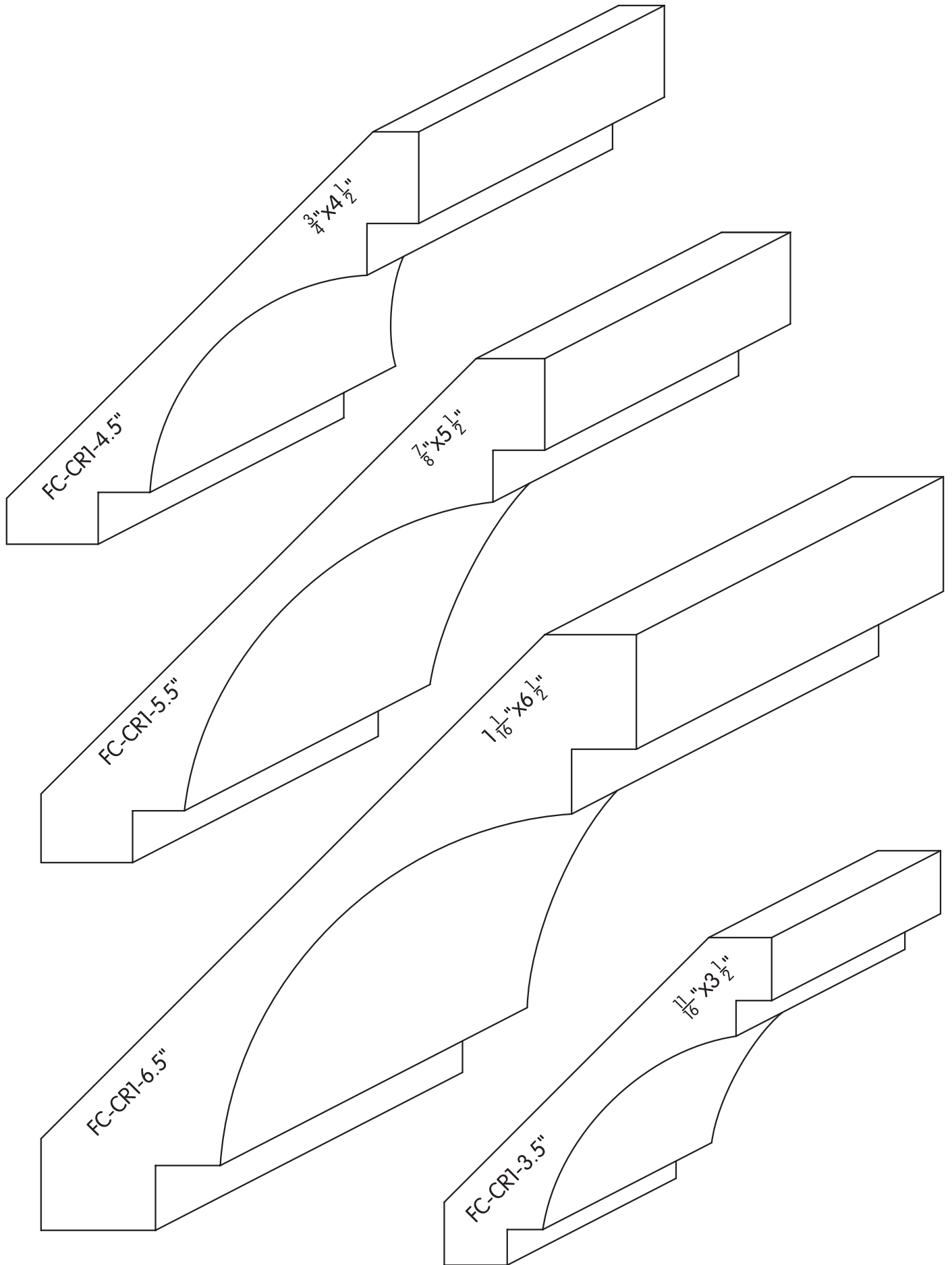

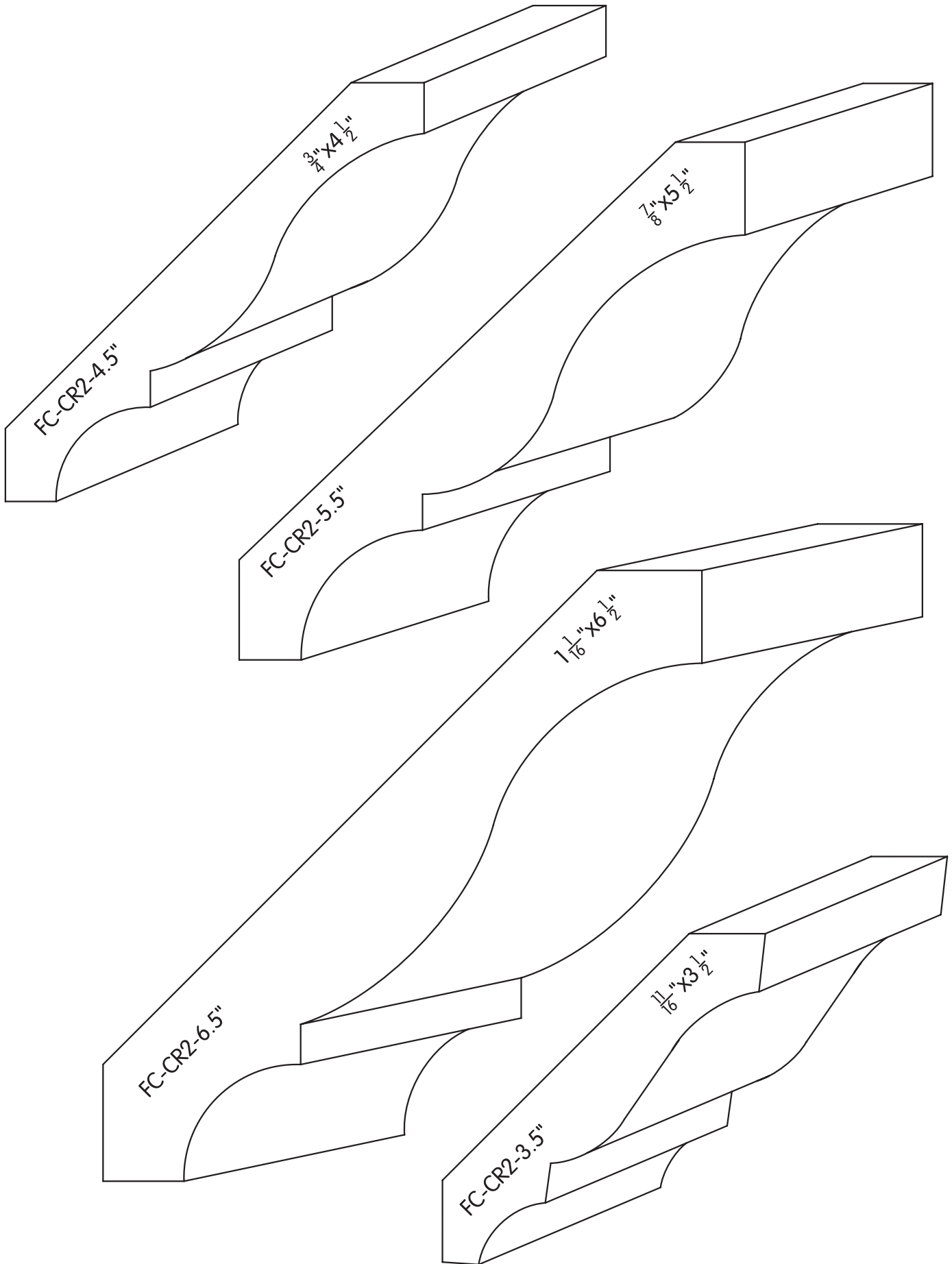

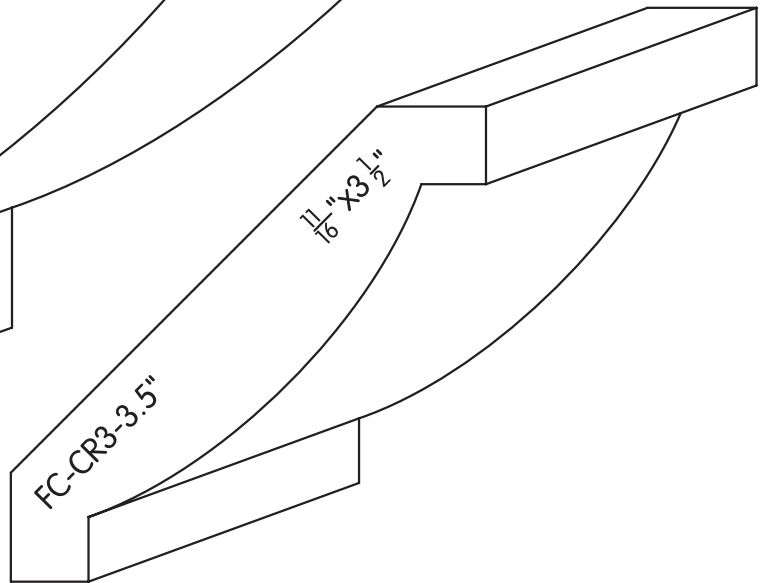
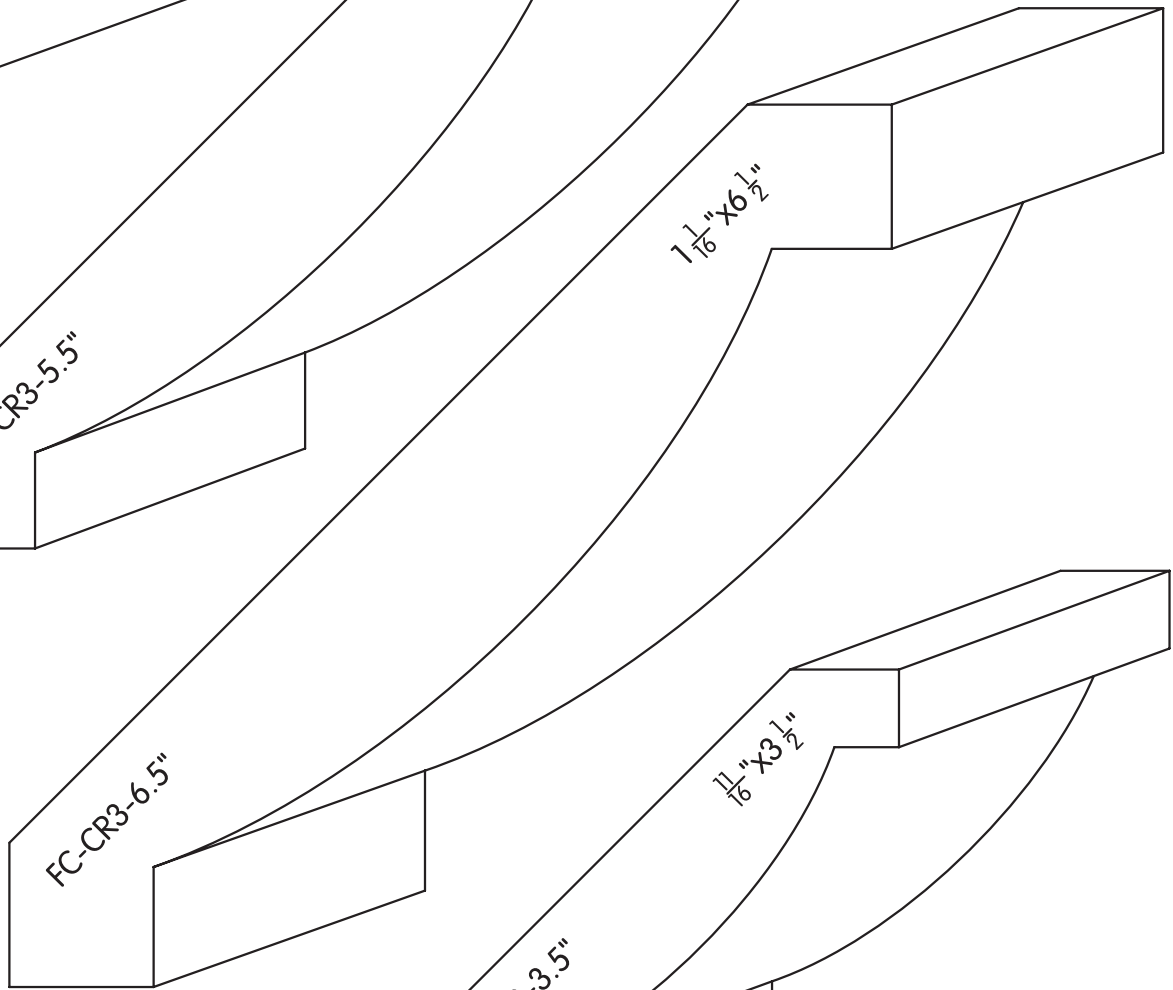
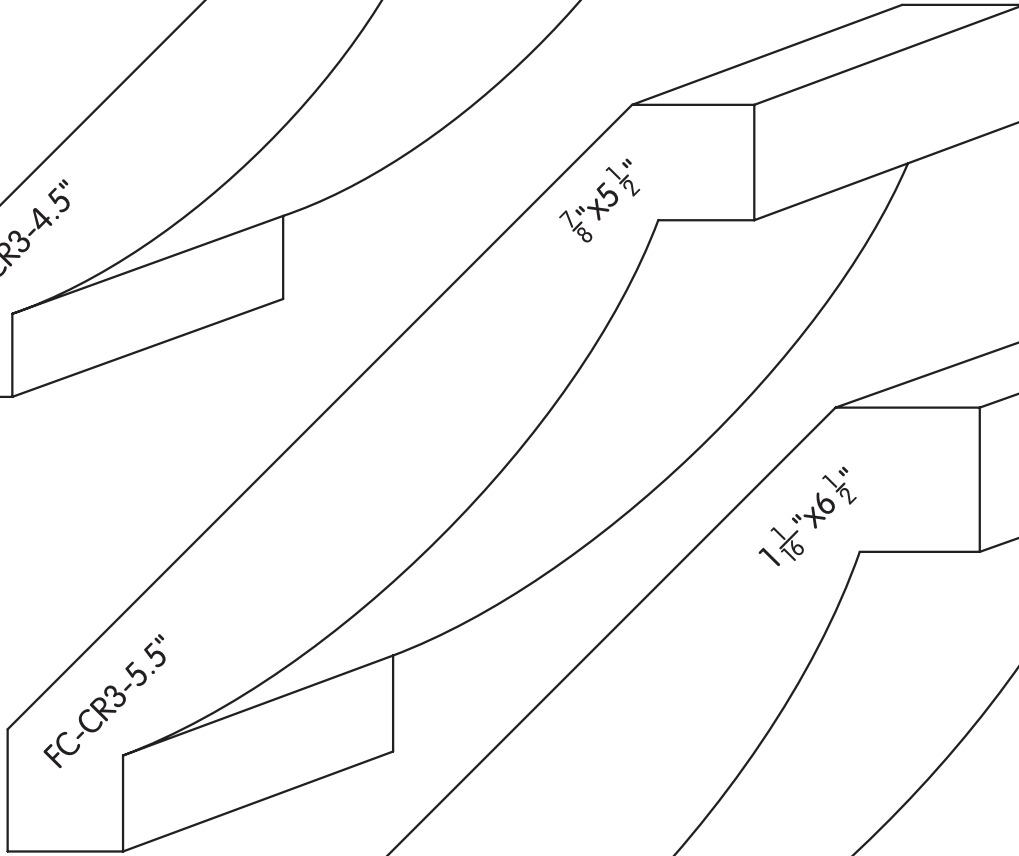
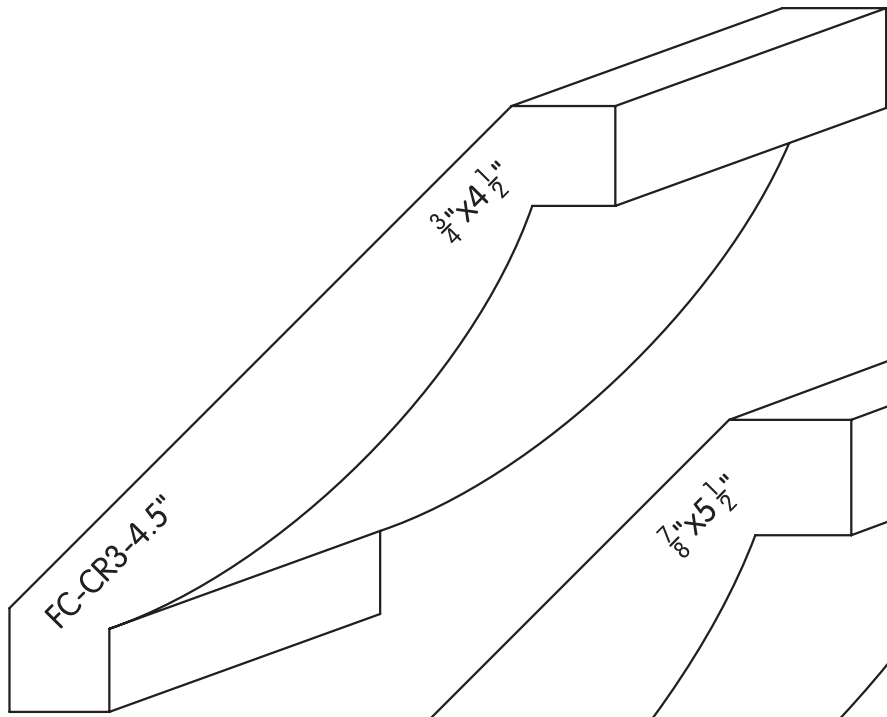

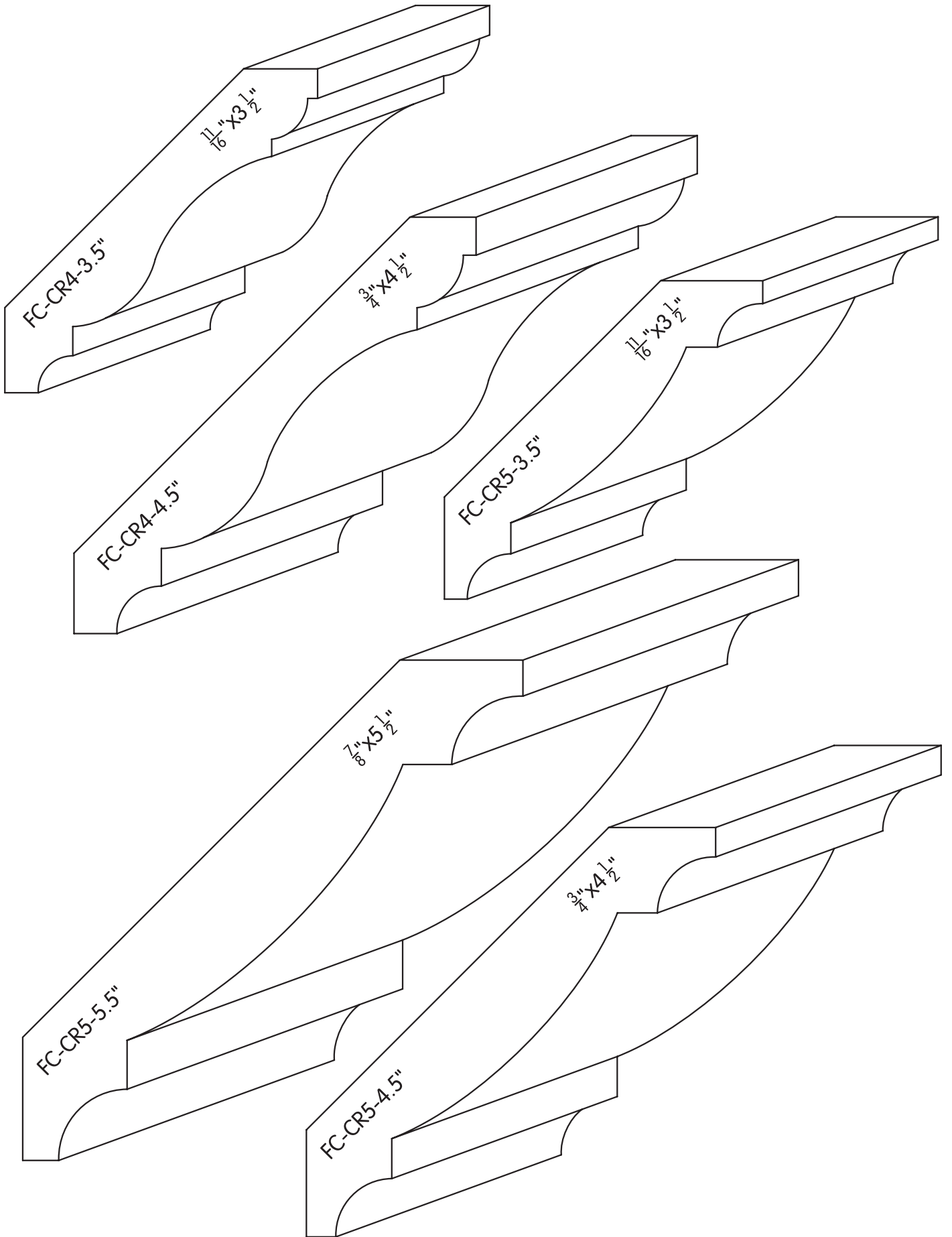

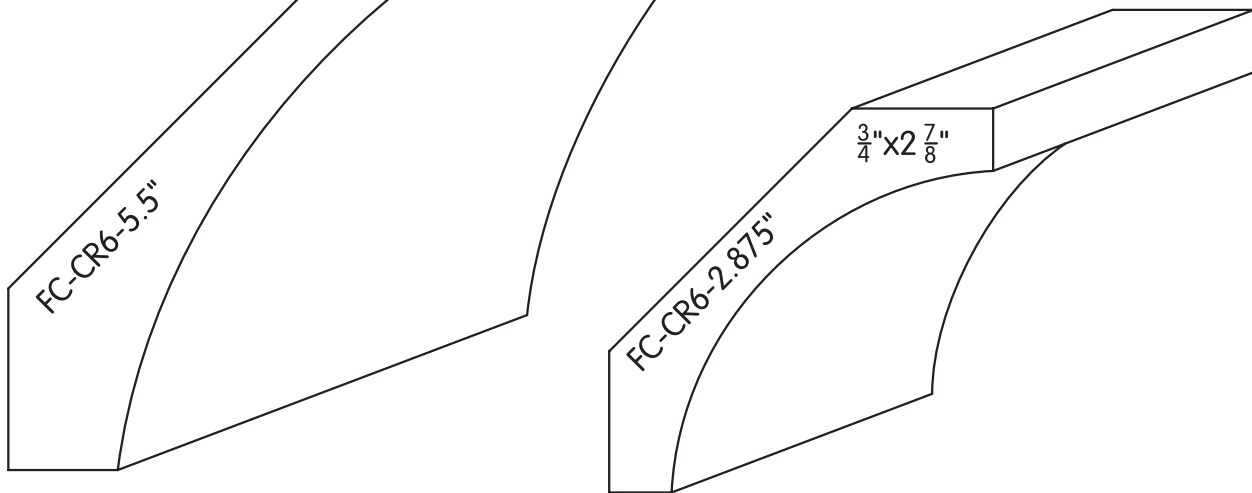
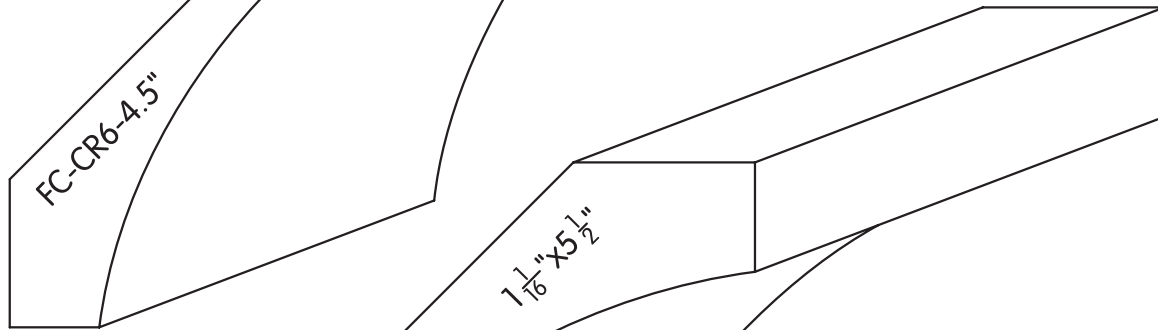
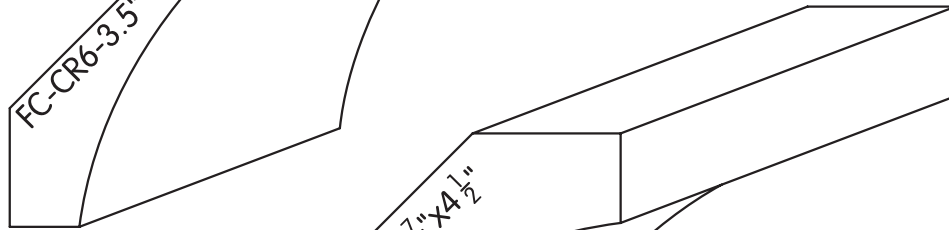
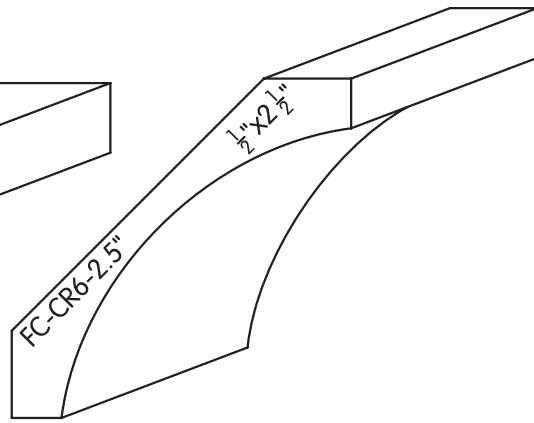
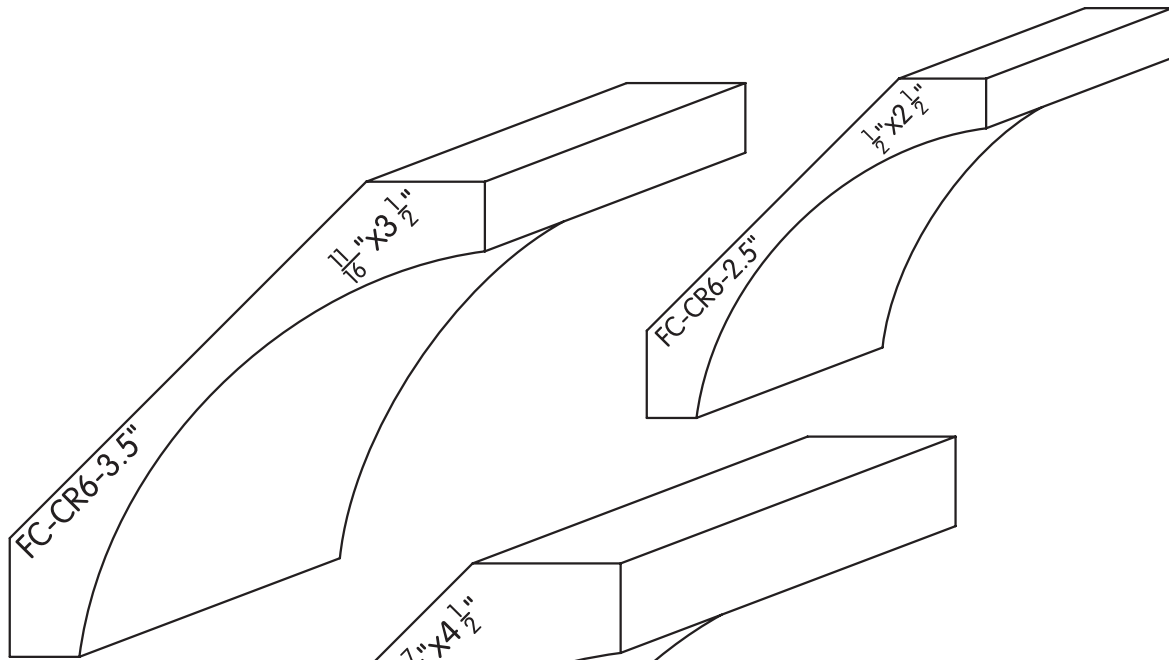

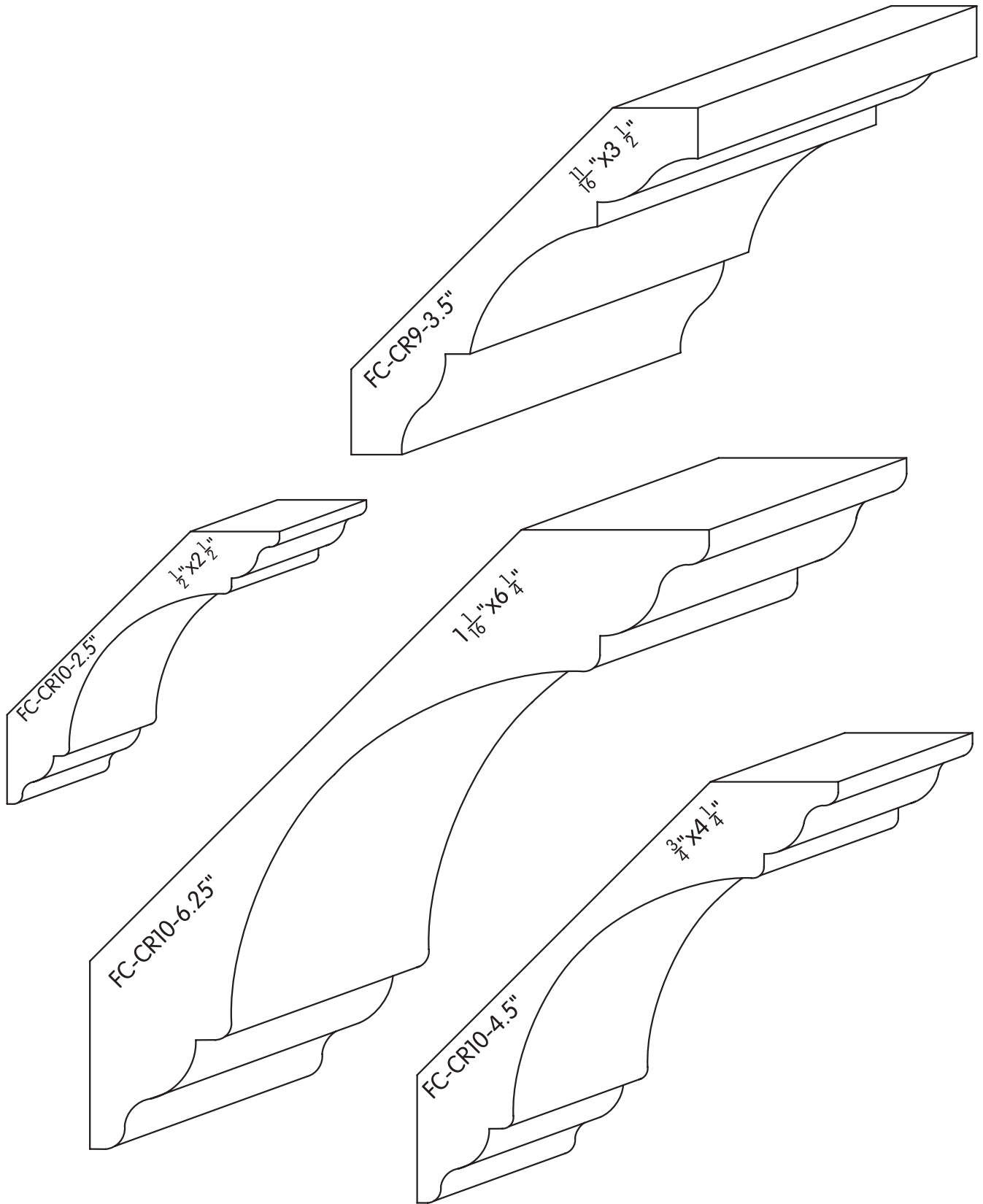

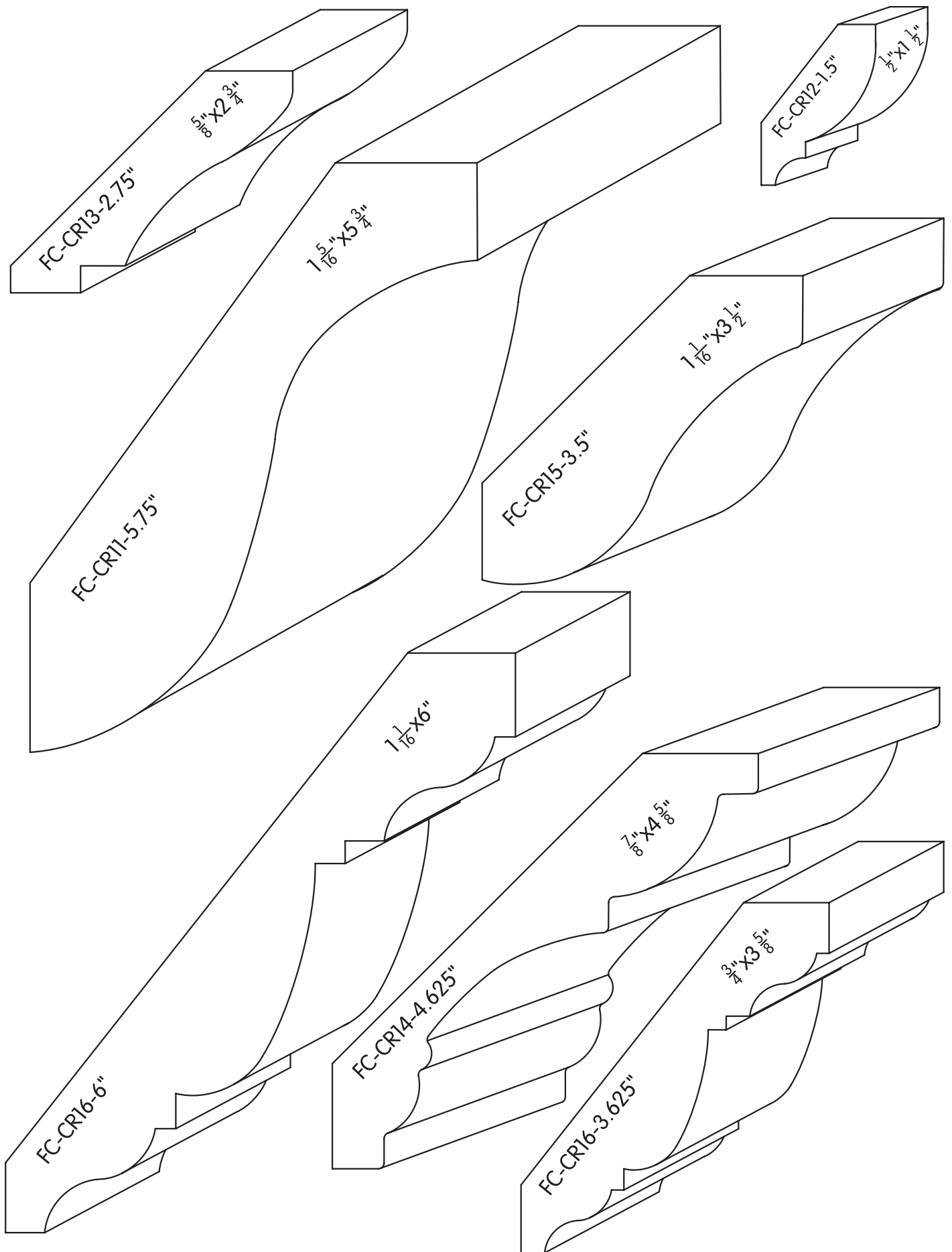

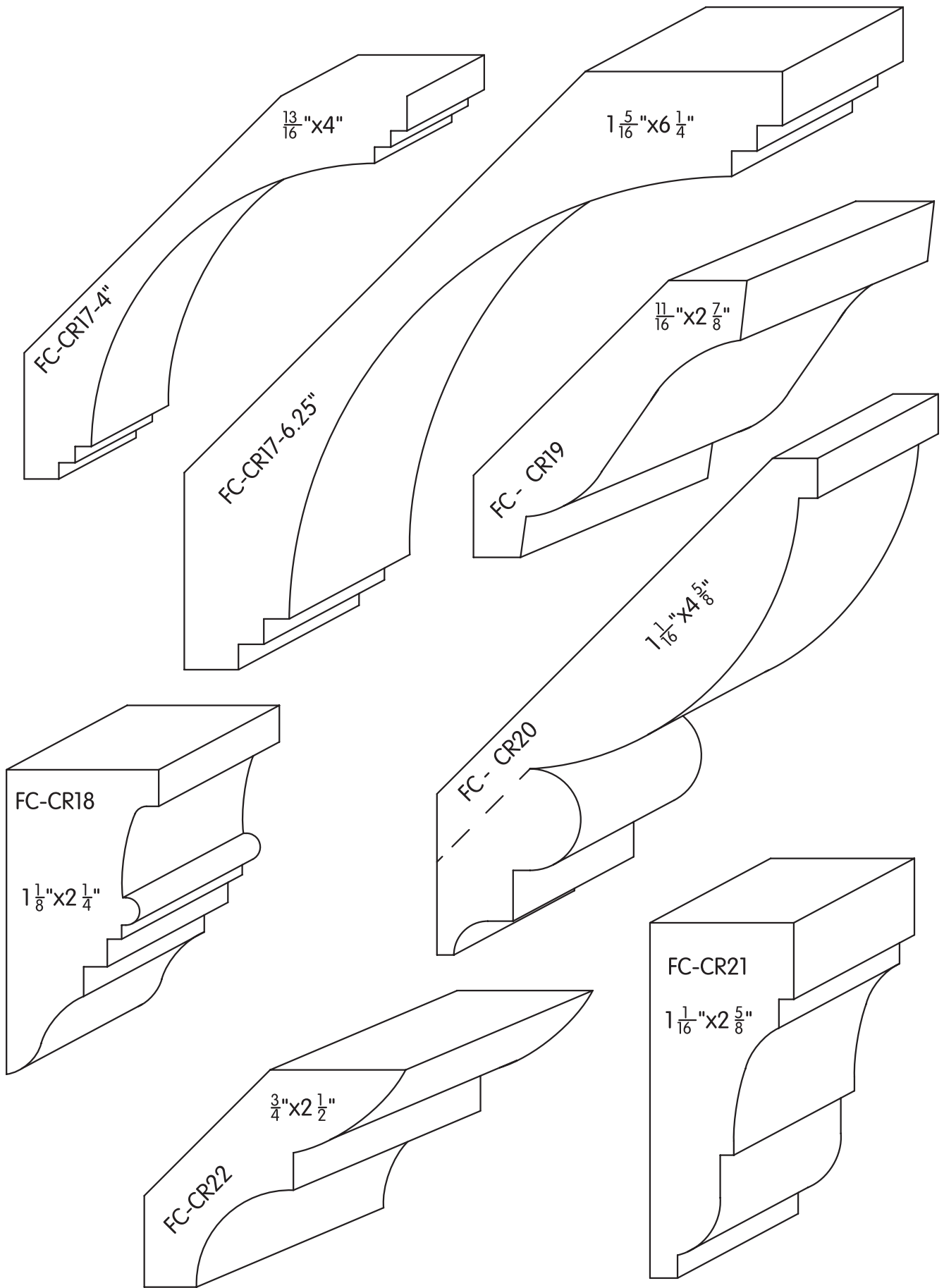

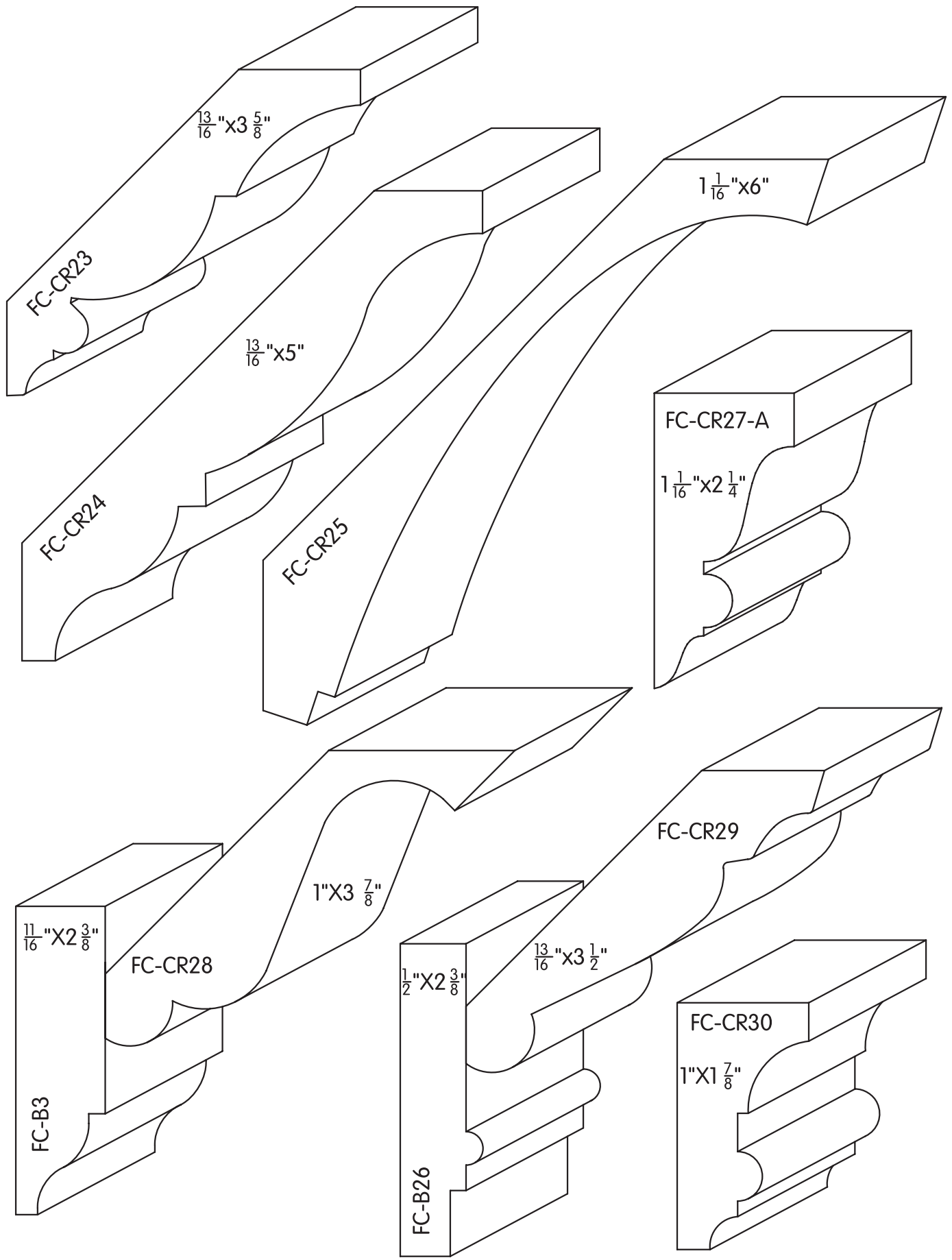

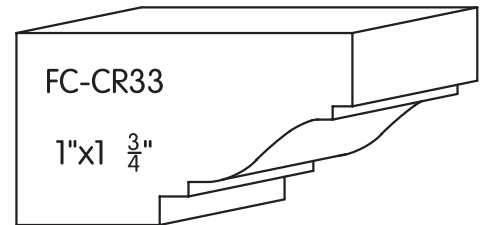
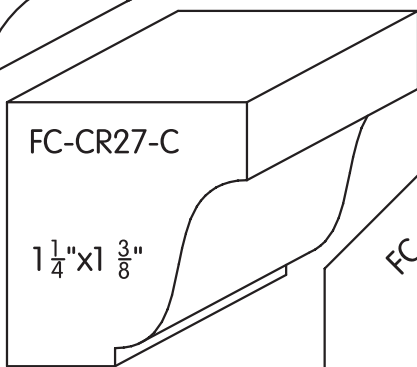
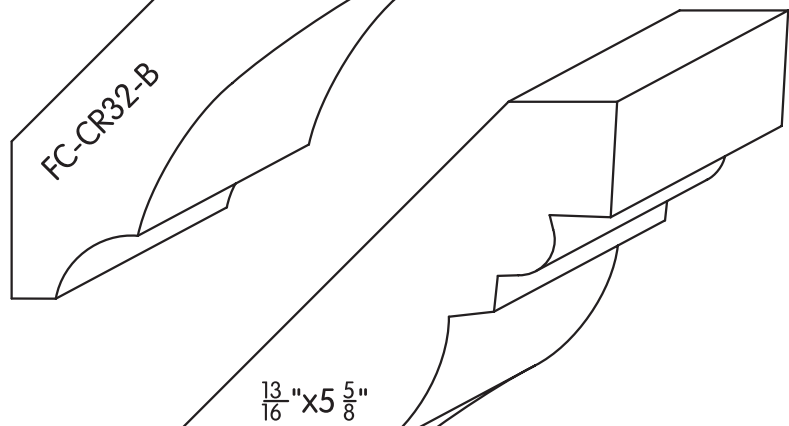
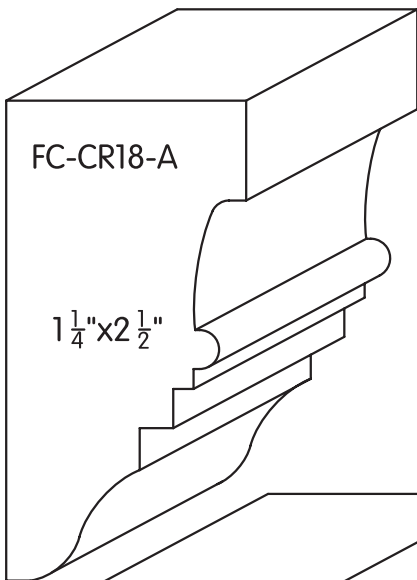
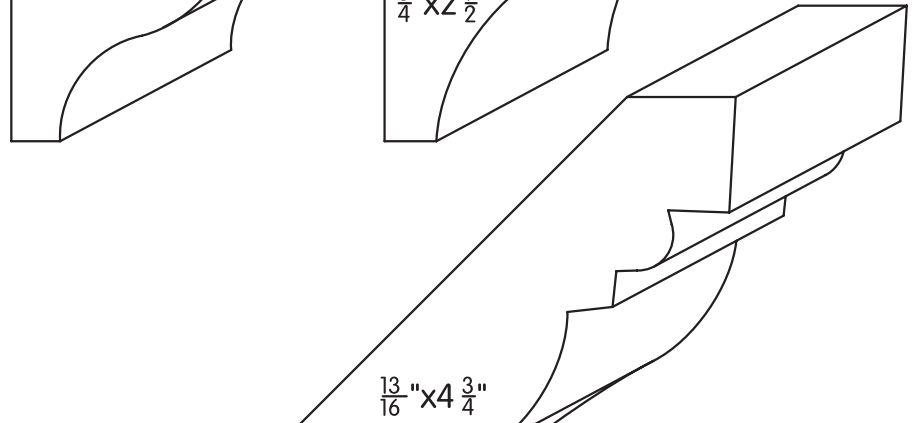
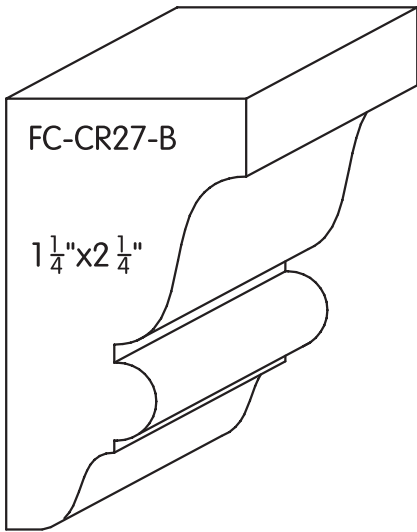
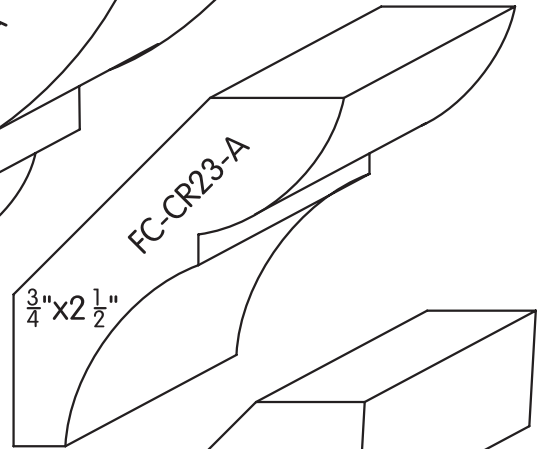
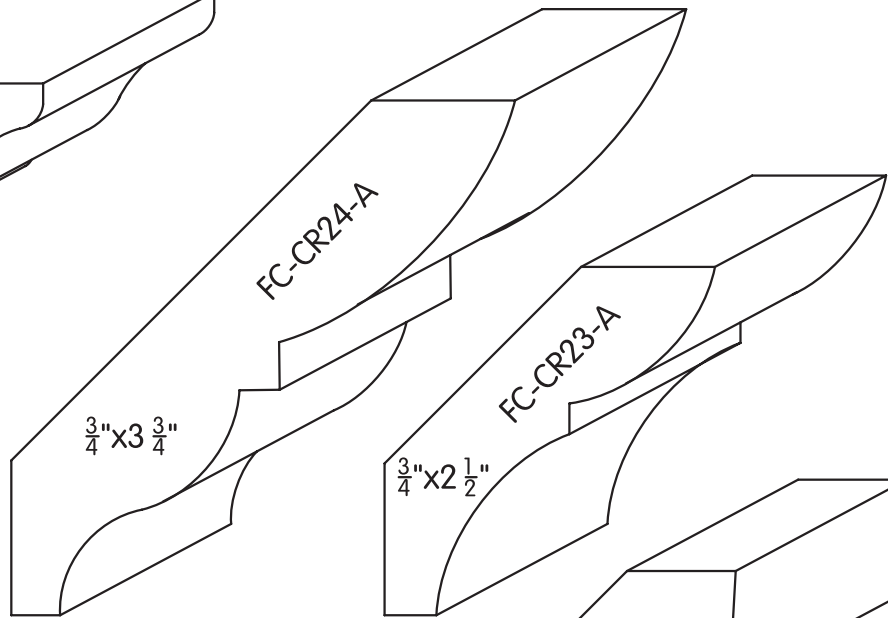
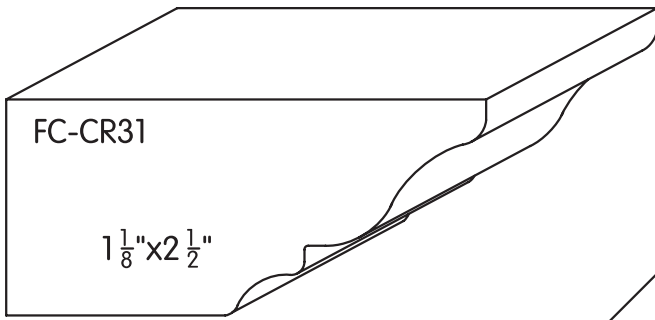

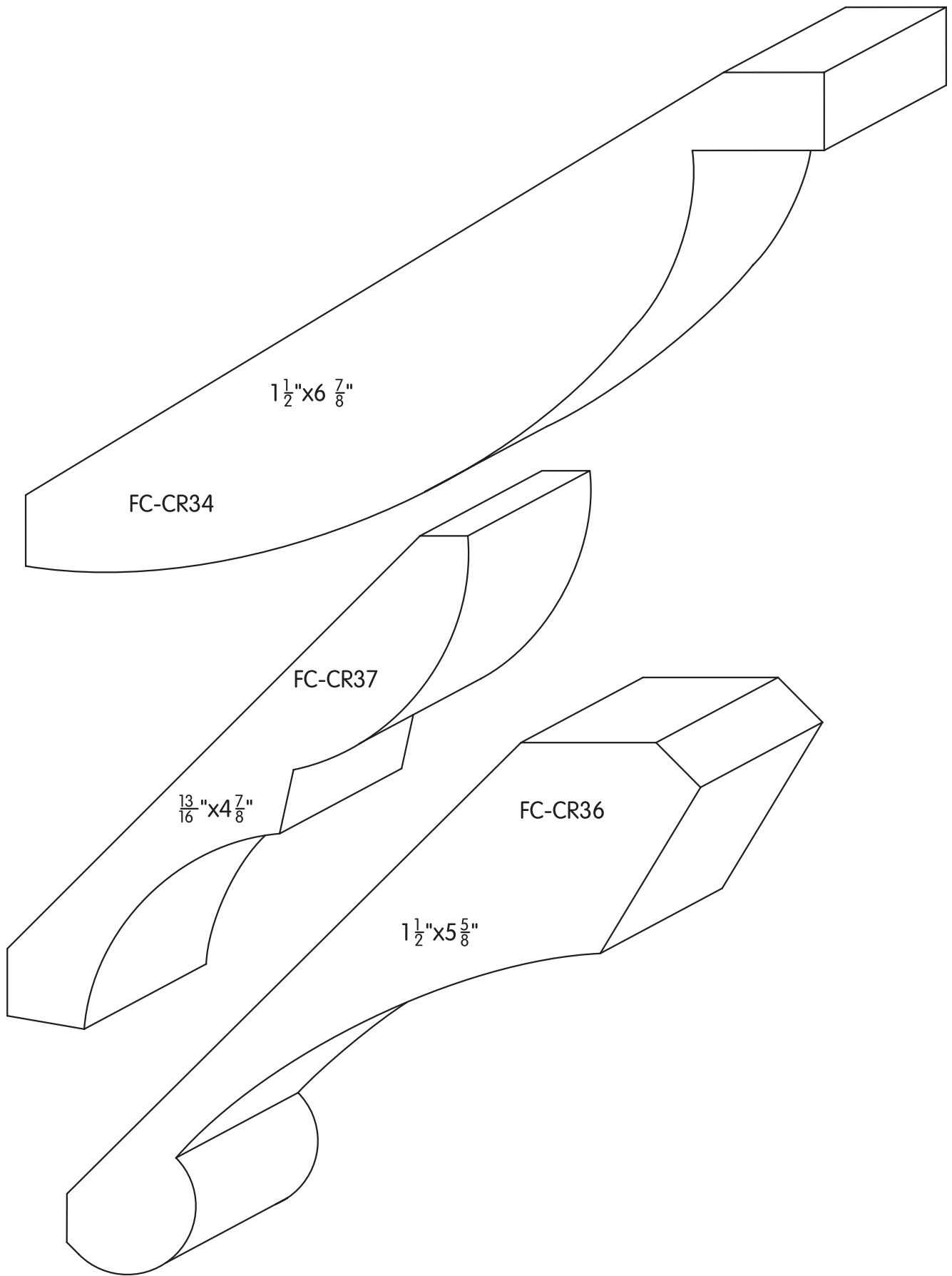

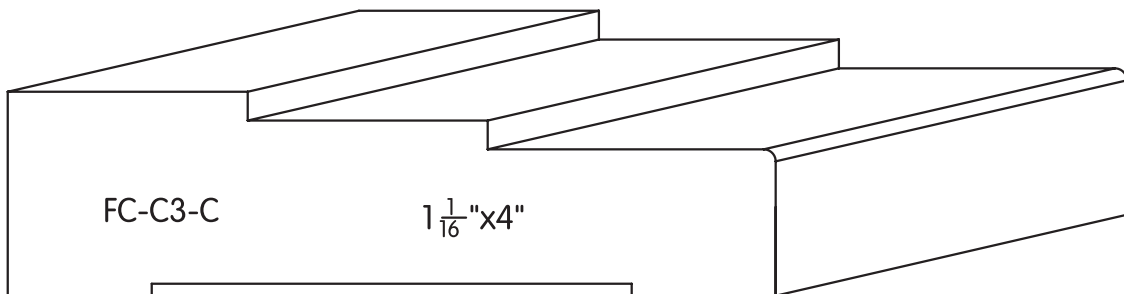
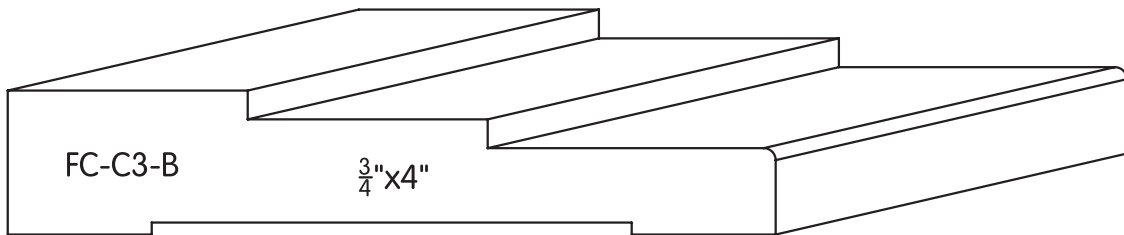
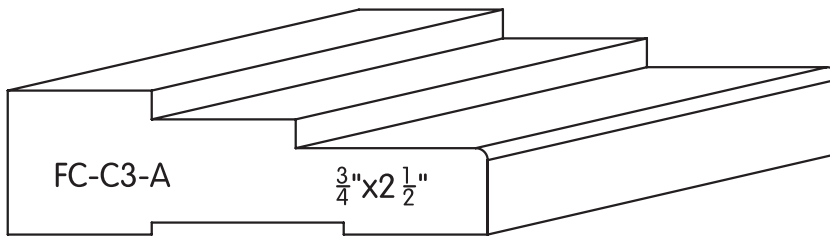
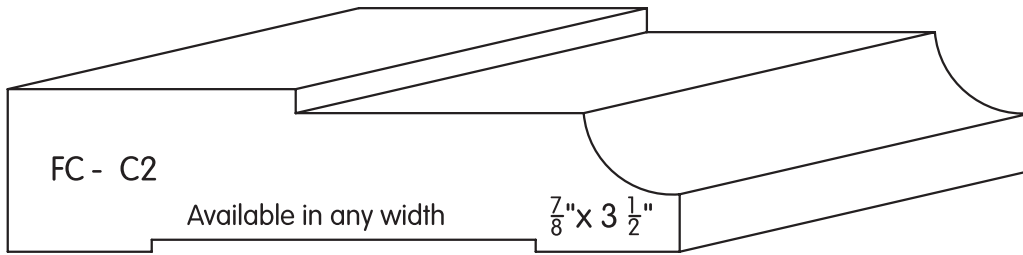
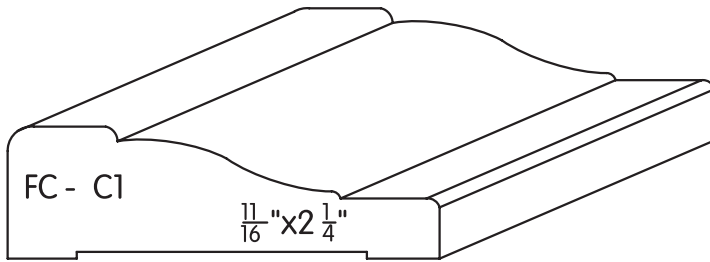

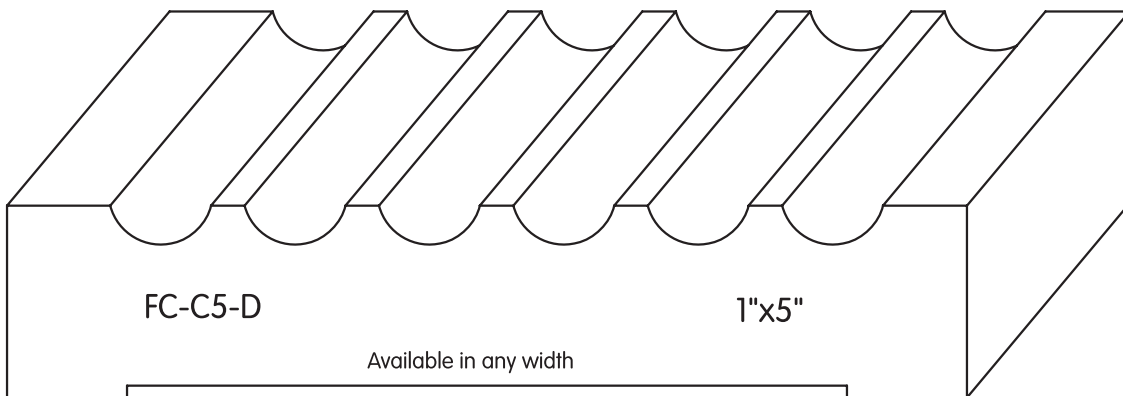
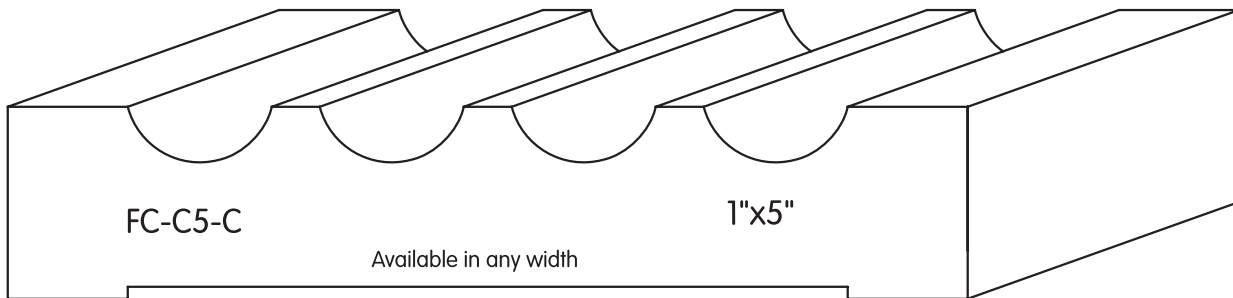
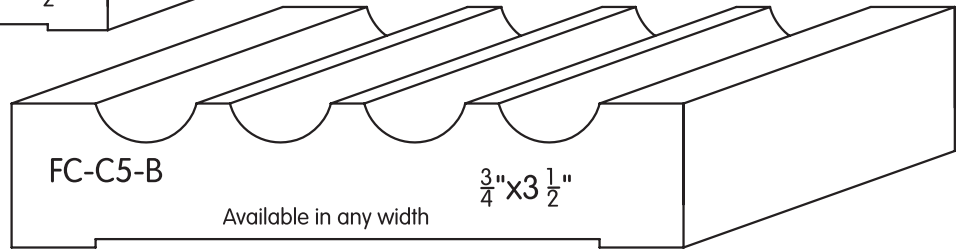
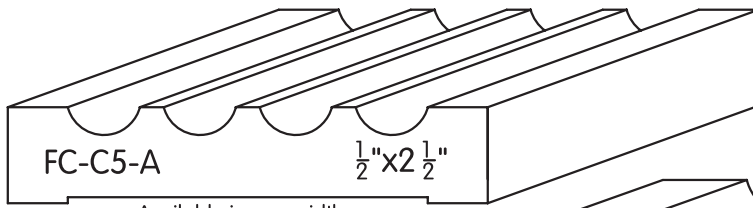
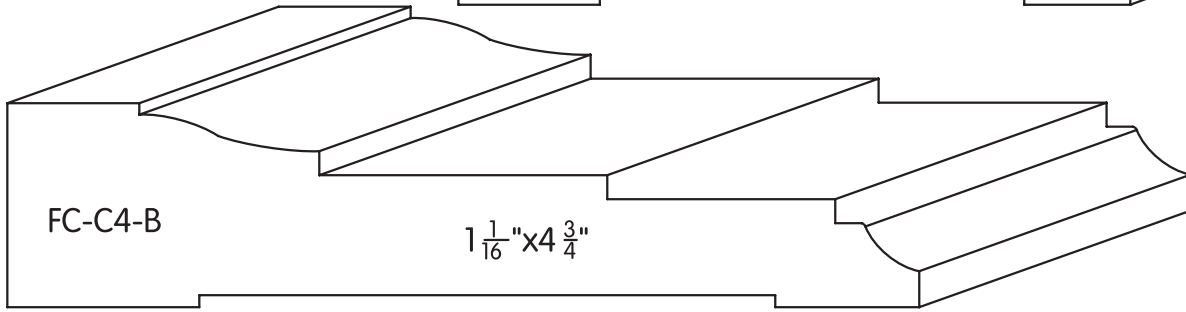
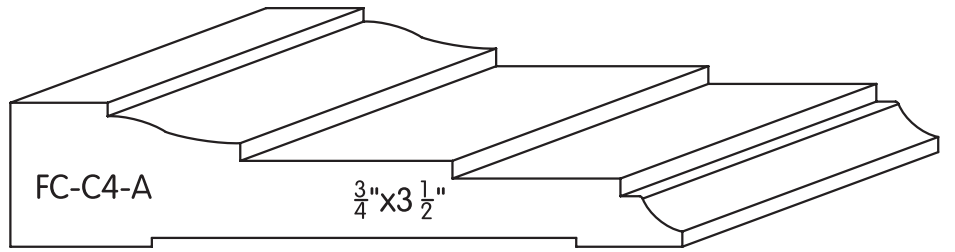

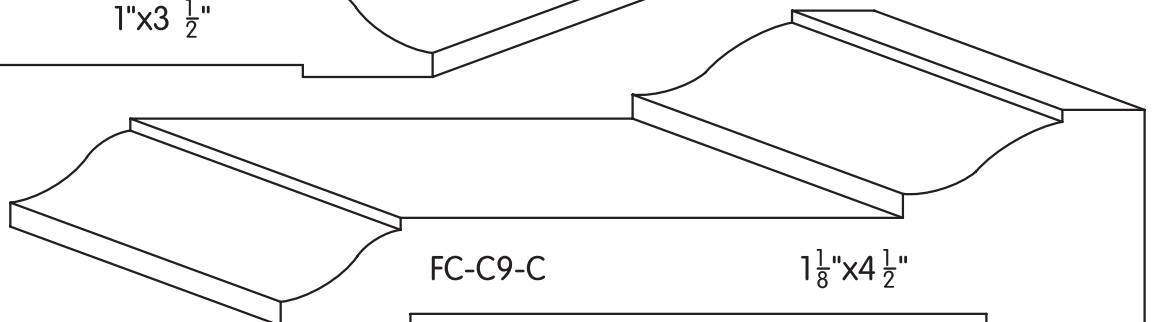
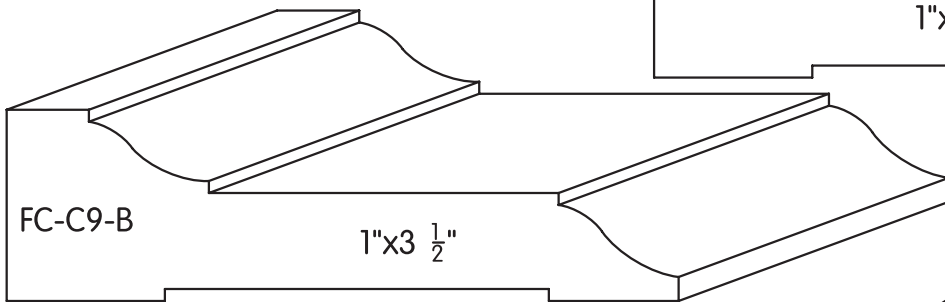
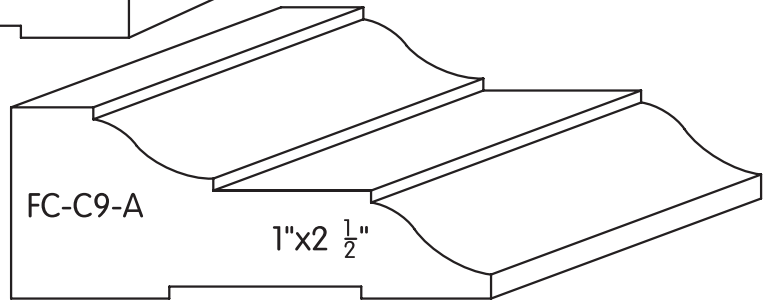
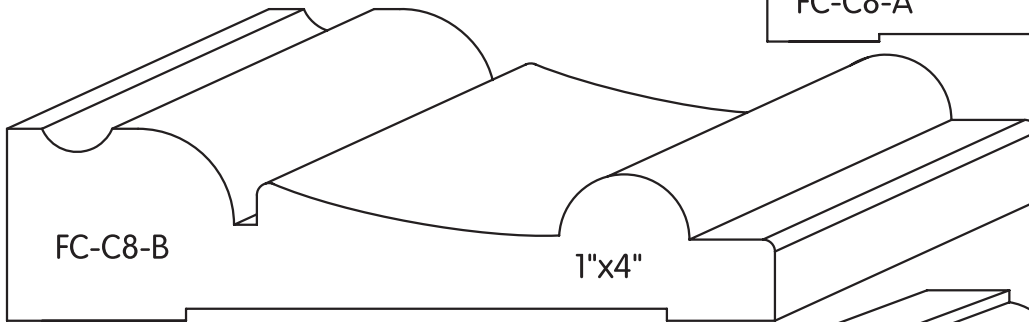
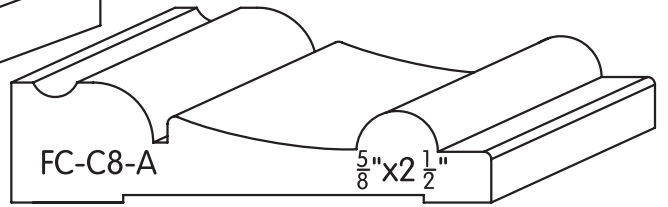
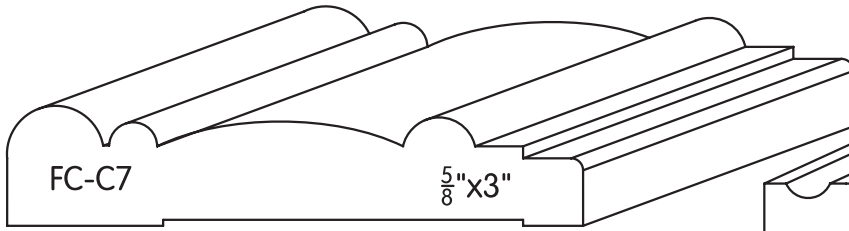
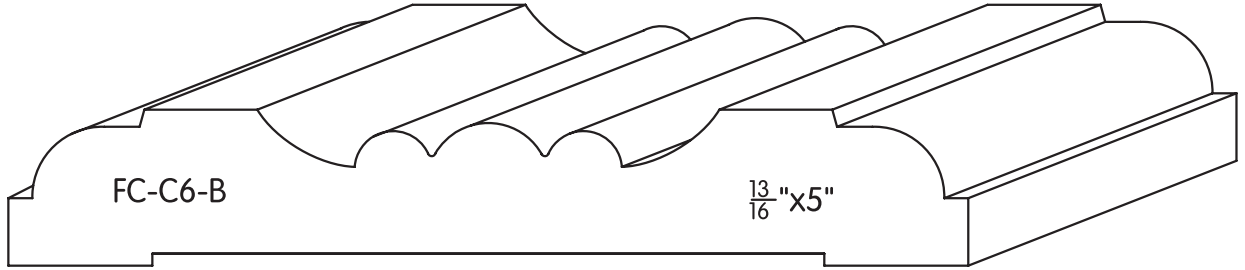
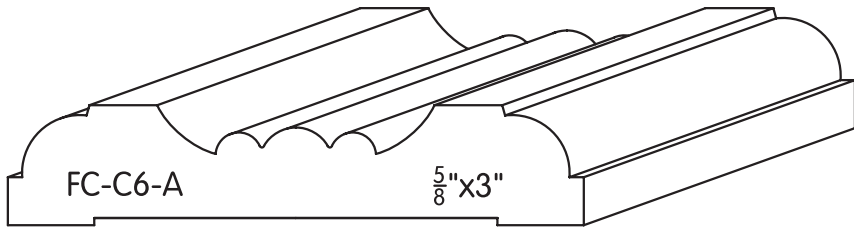

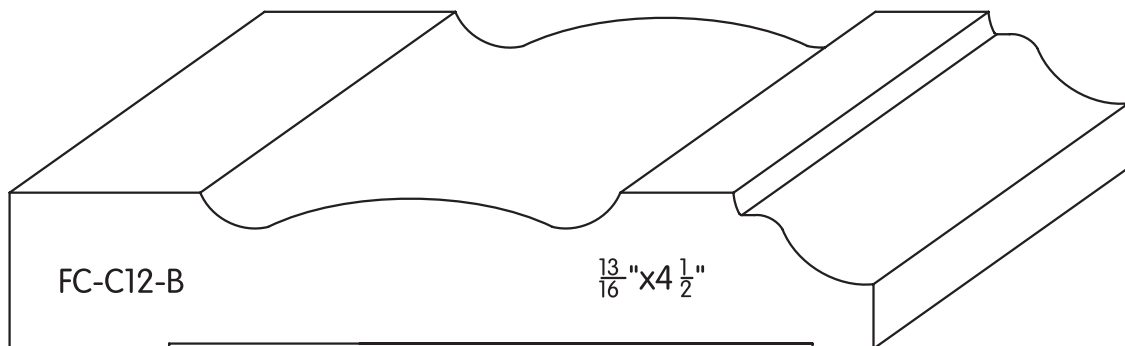
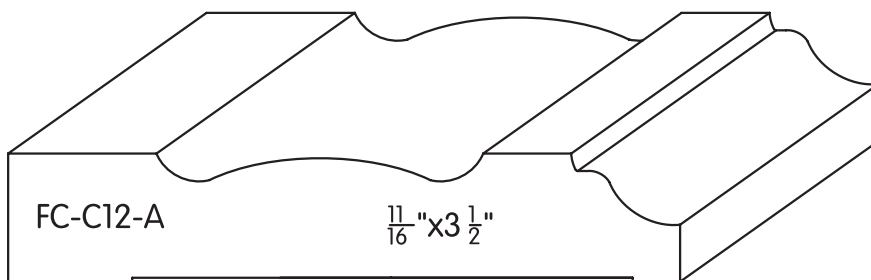
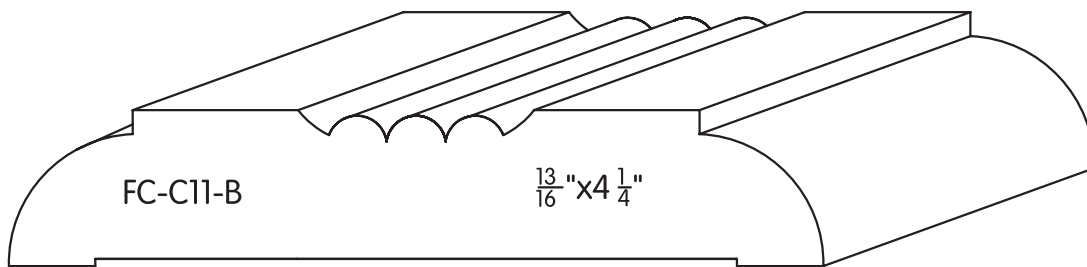
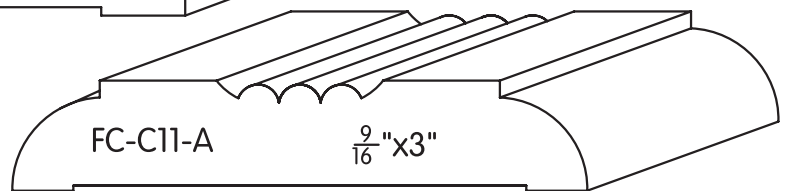
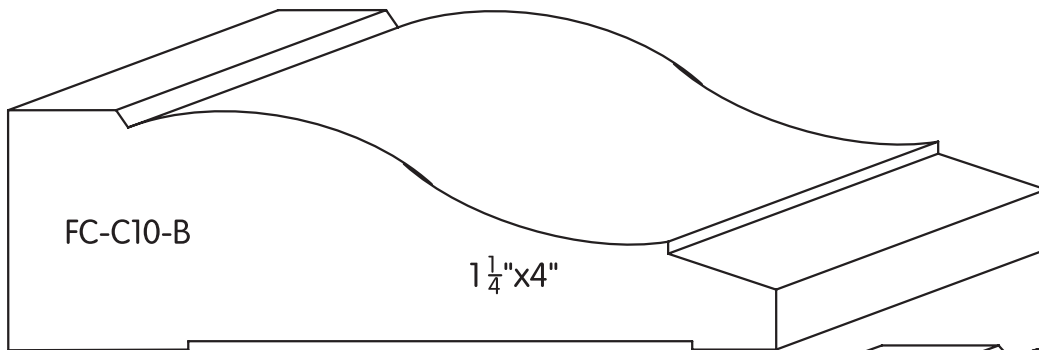
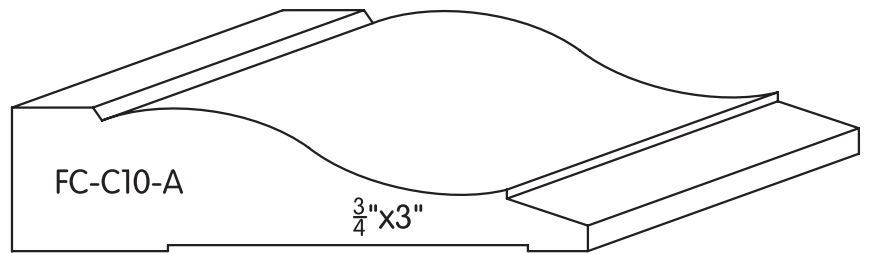

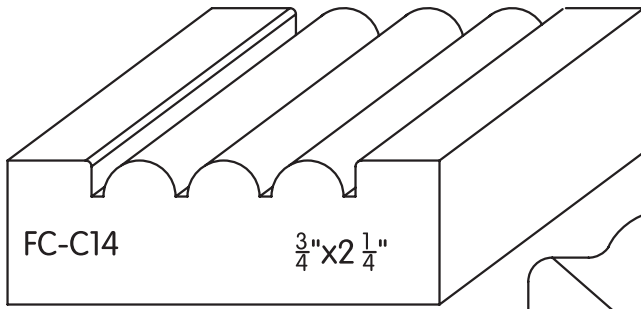

FC-C14

$\frac{3}{4}$ " x $2\frac{1}{4}$ "

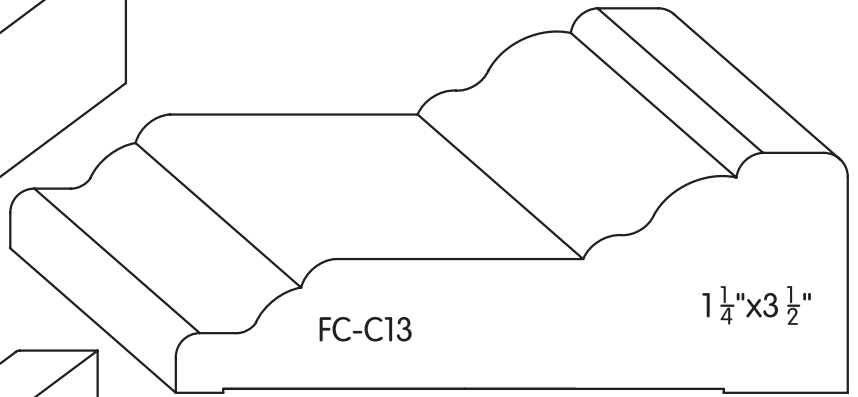

FC-C13

$1\frac{1}{4}$ " x $3\frac{1}{2}$ "

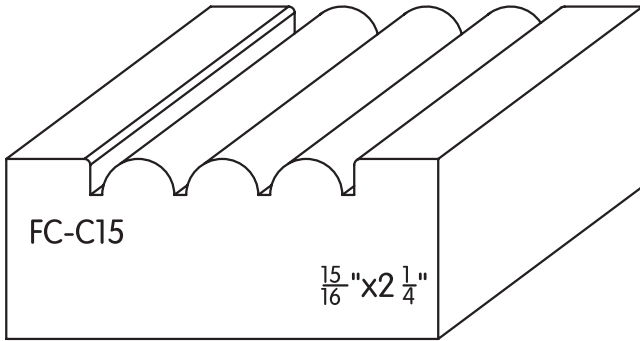

FC-C15

$\frac{15}{16}$ " x $2\frac{1}{4}$ "

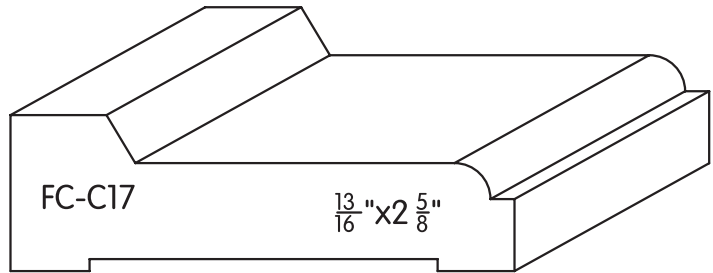

FC-C17

$\frac{13}{16}$ " x $2\frac{5}{8}$ "

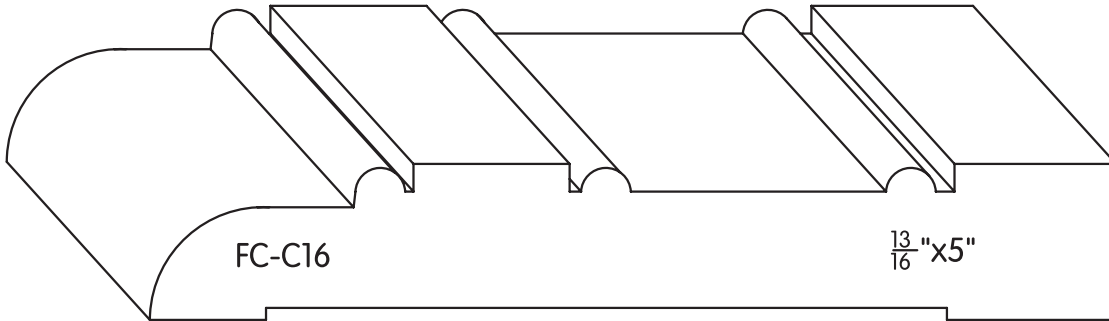

FC-C16

$\frac{13}{16}$ " x 5"

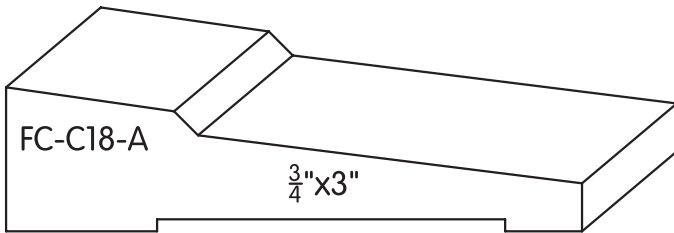

FC-C18-A

$\frac{3}{4}$ " x 3"

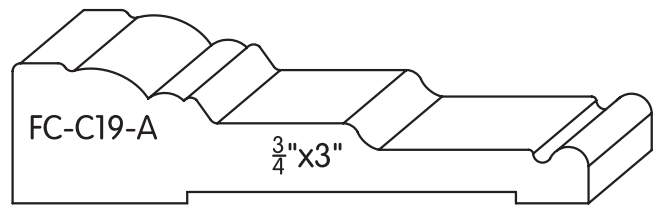

FC-C19-A

$\frac{3}{4}$ " x 3"

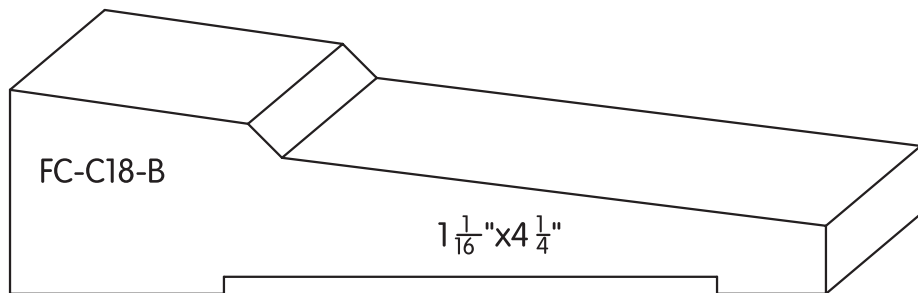

FC-C18-B

$1\frac{1}{16}$ " x $4\frac{1}{4}$ "



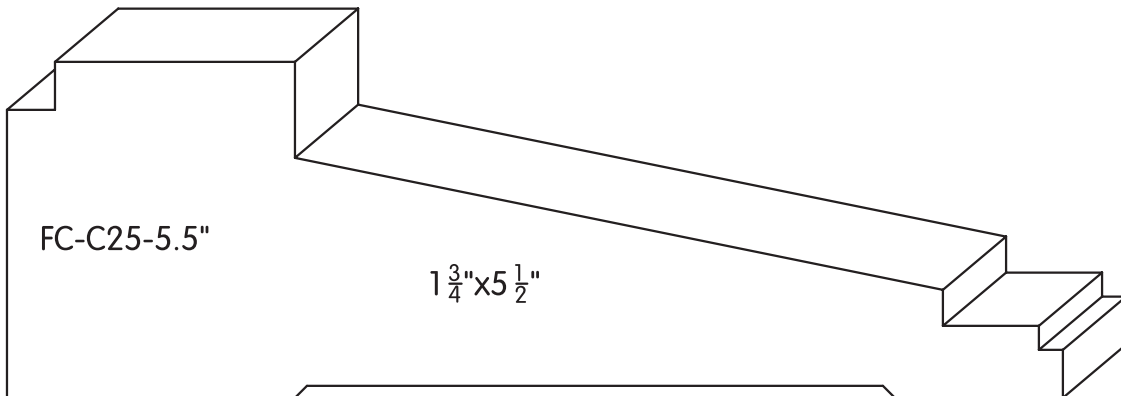
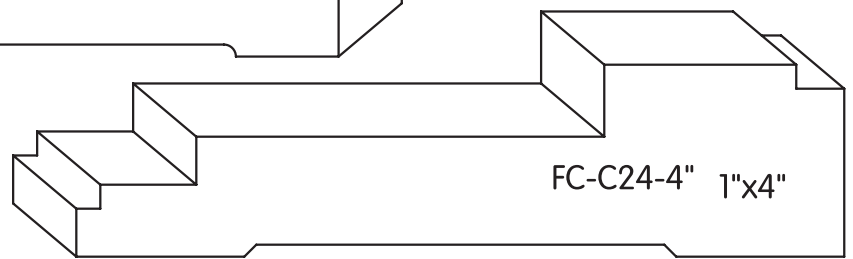
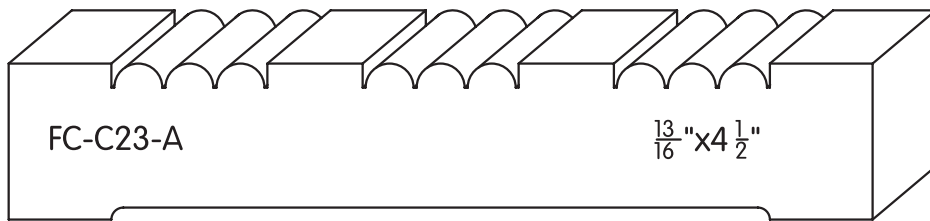
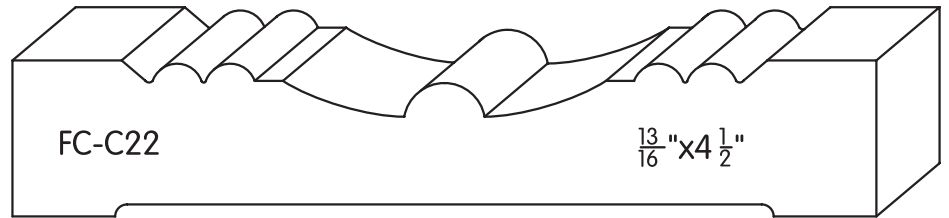
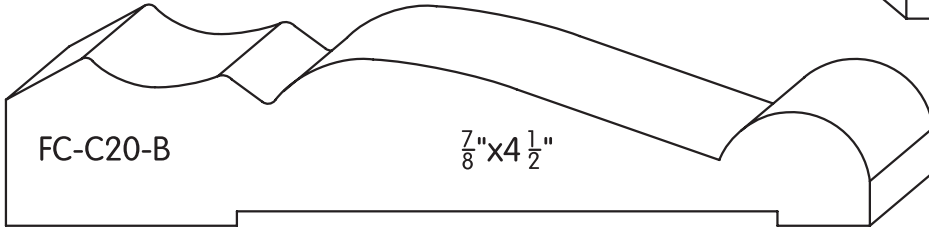
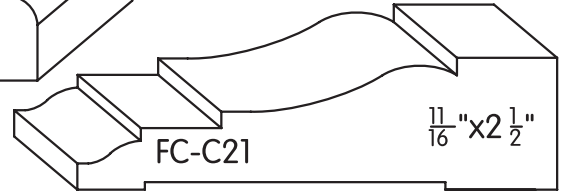
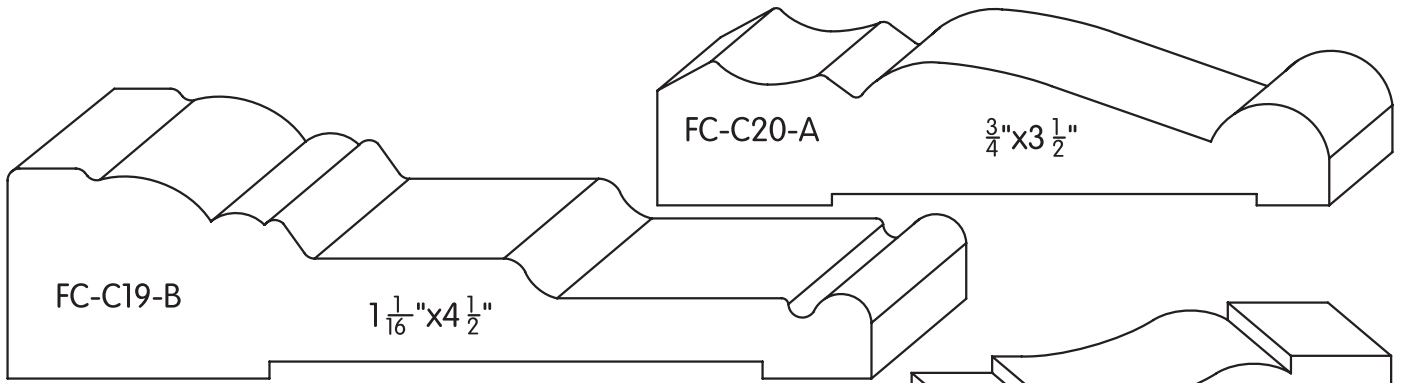

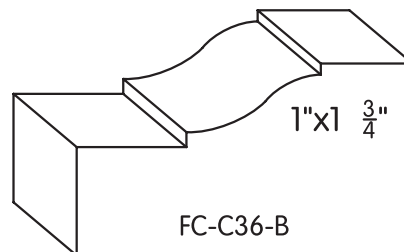
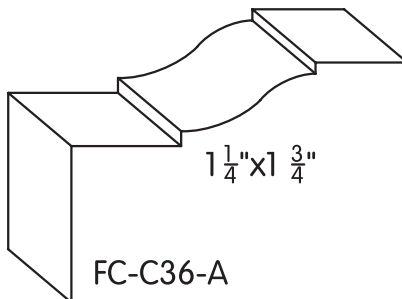
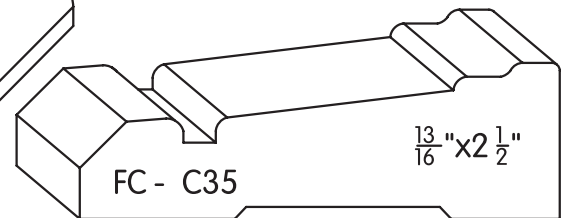
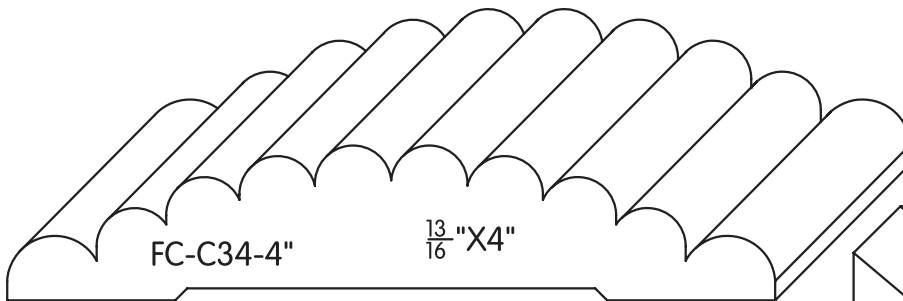
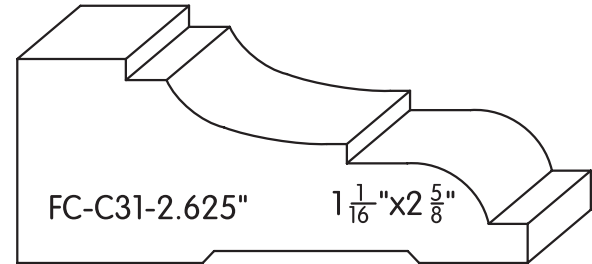
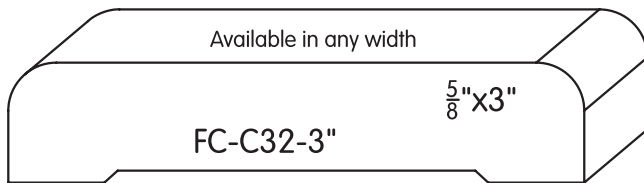
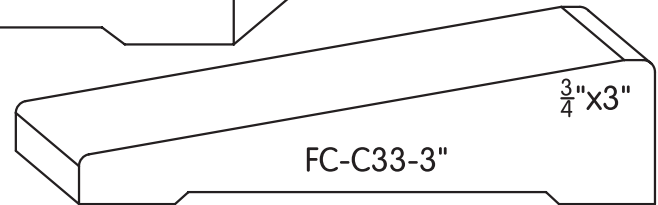
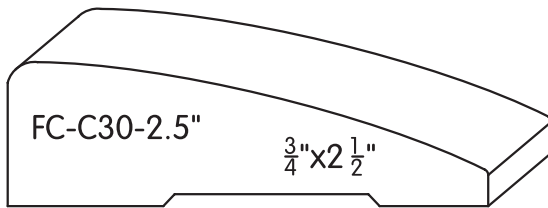
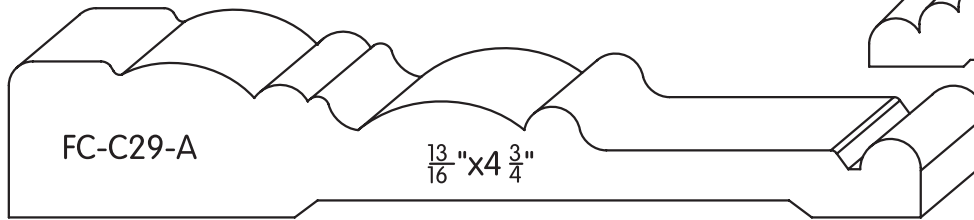
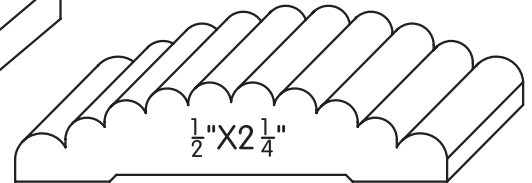
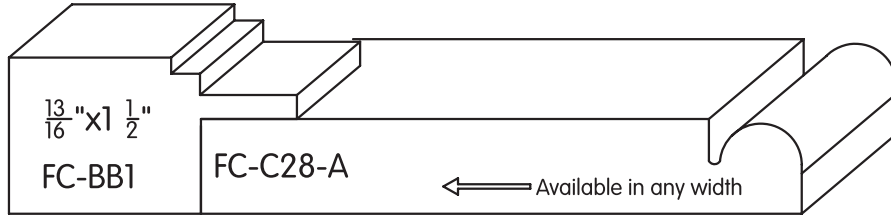
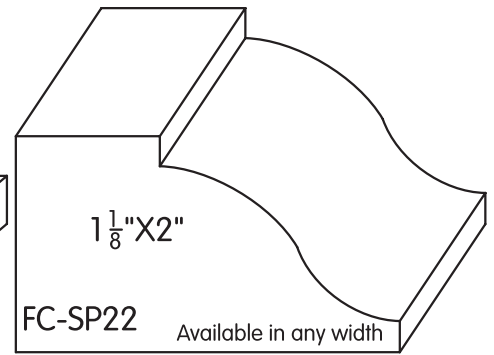
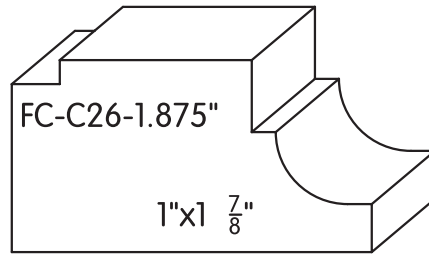
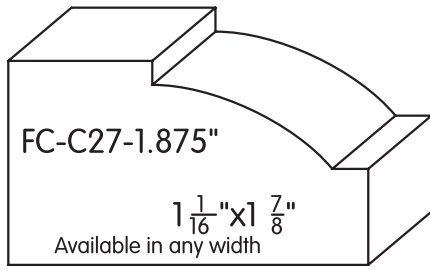

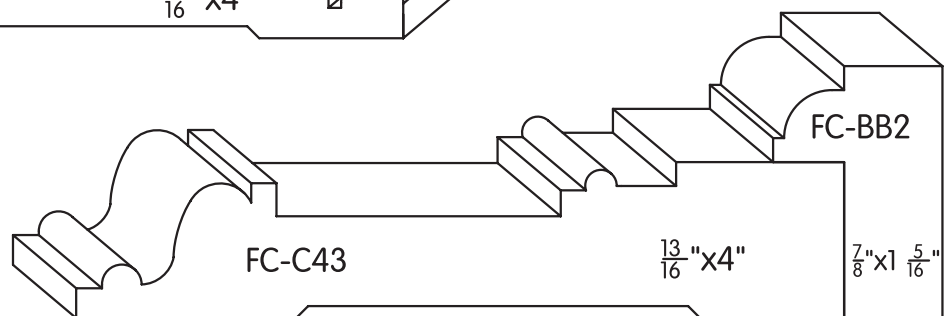
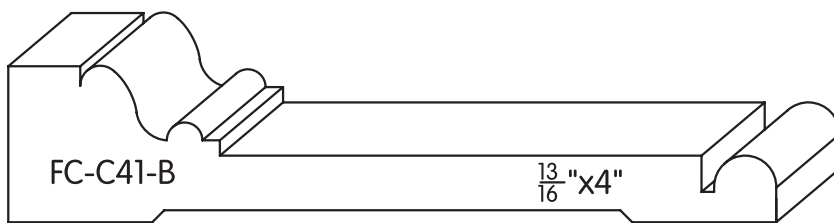
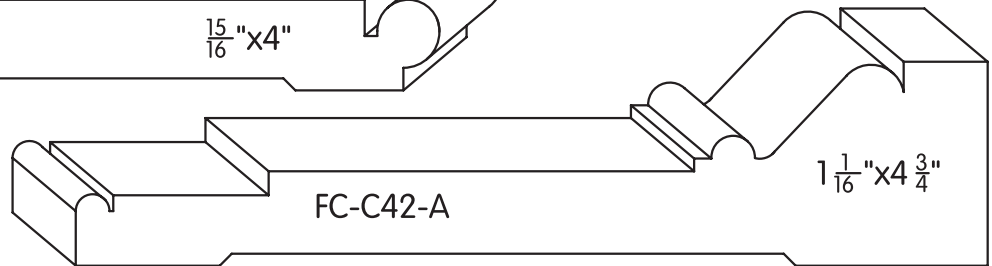
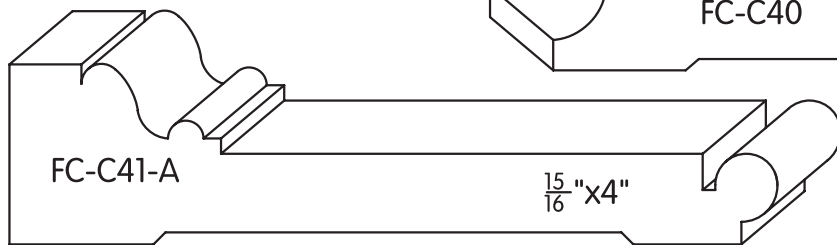
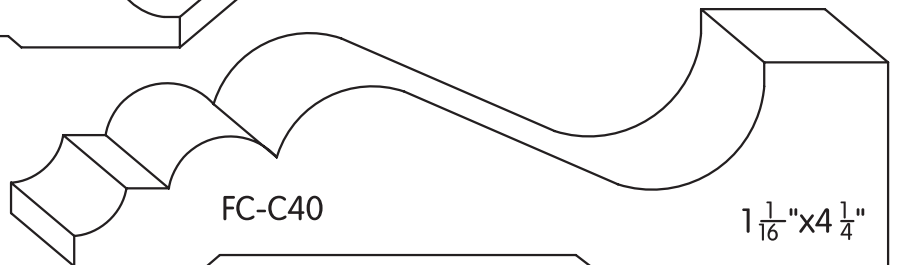
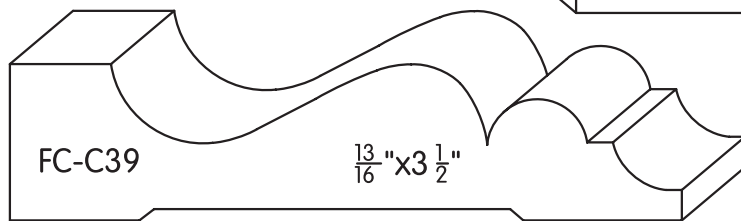
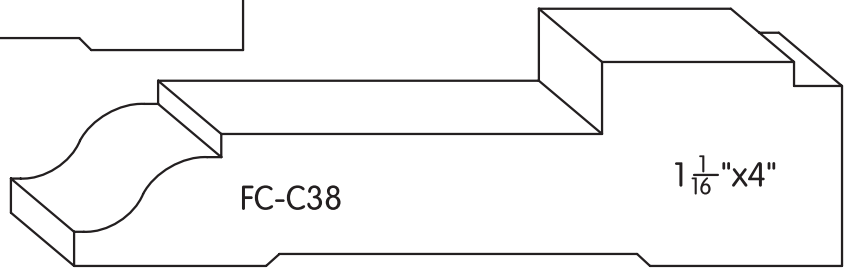
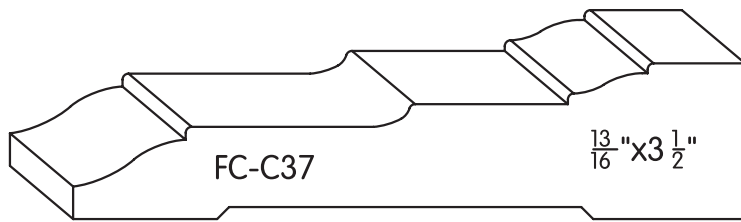

Shown With Optional Backband



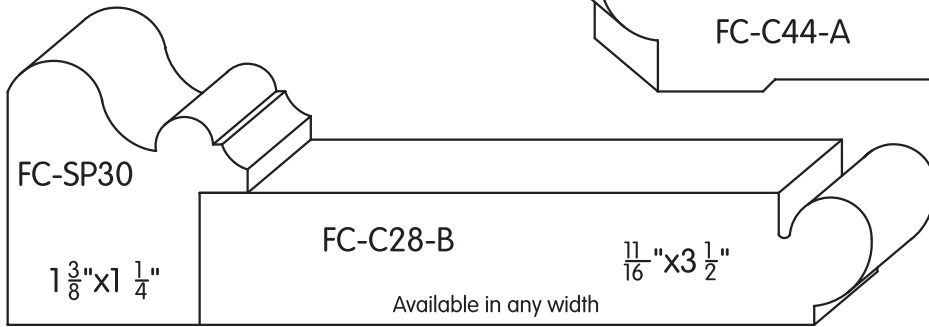
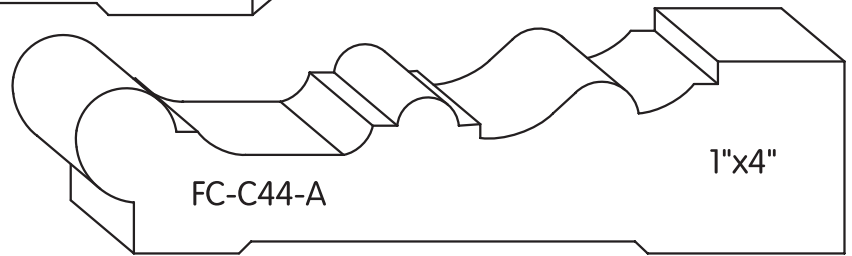
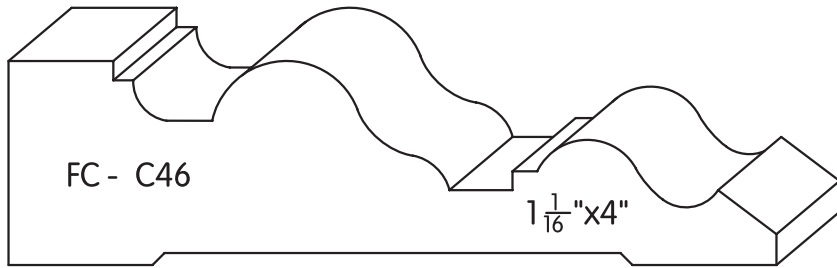
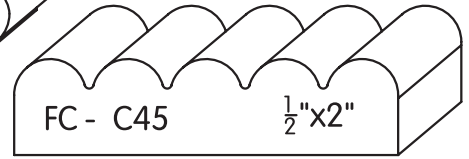
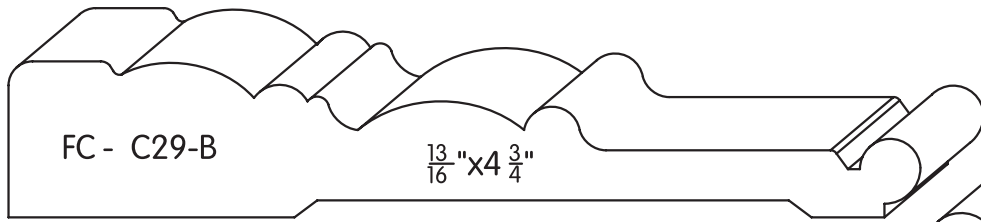

Shown With Optional Backband

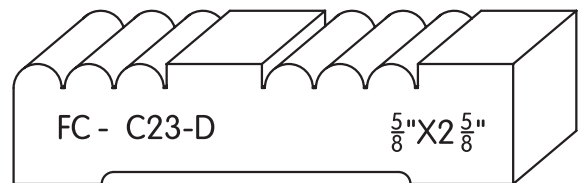
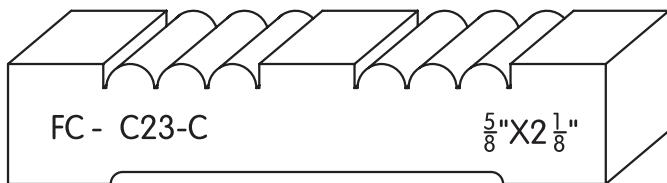
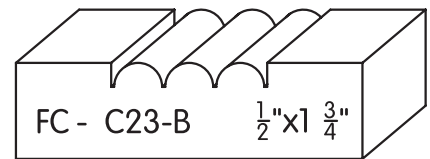
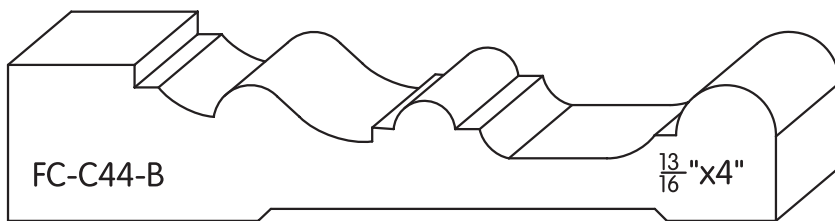
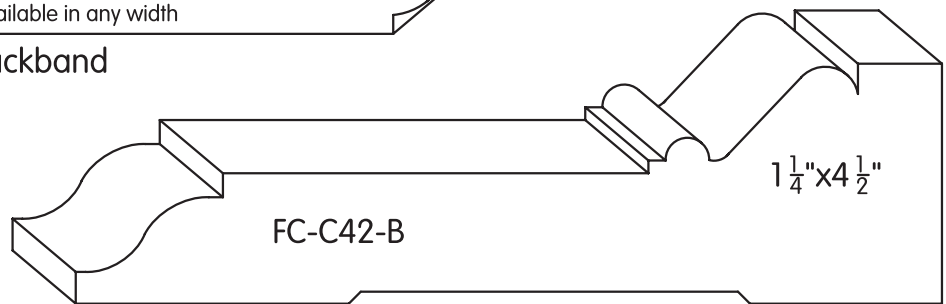

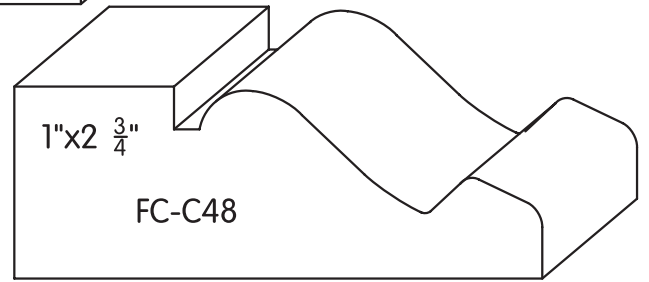
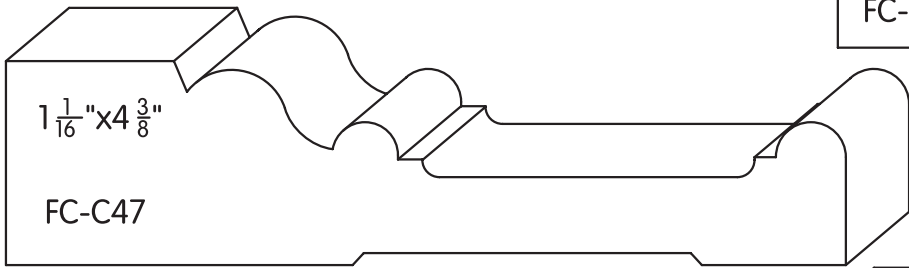
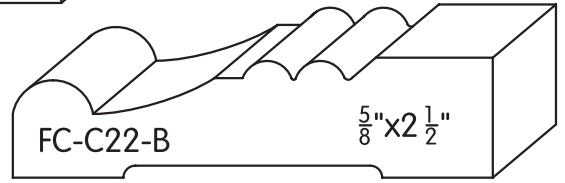
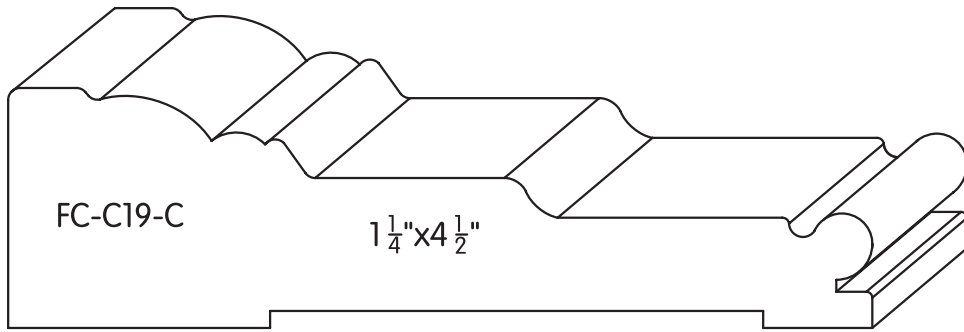

← Available in any width

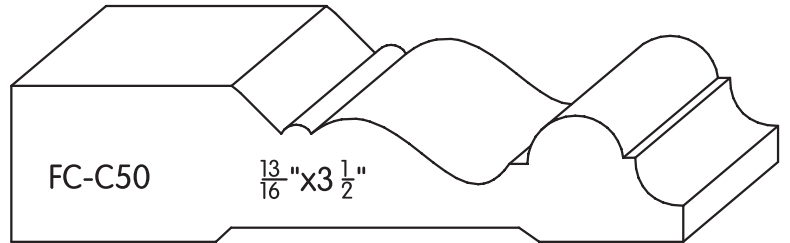
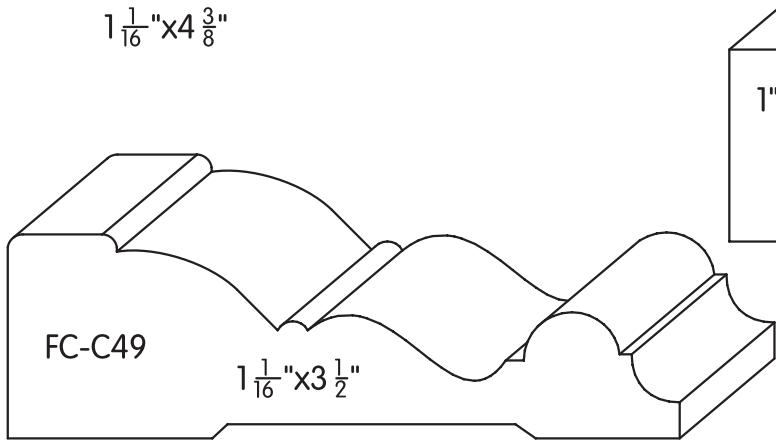

← Available in any width

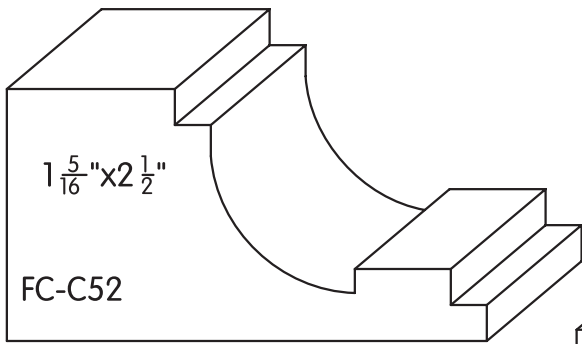

← Available in any width

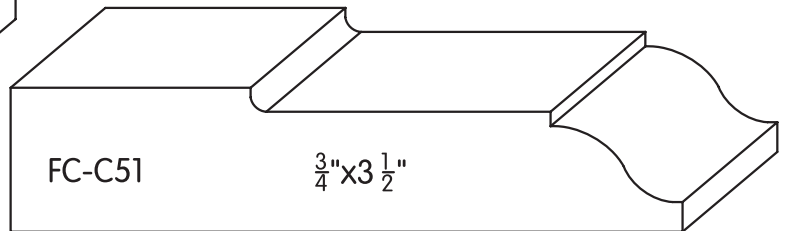

← Available in any width



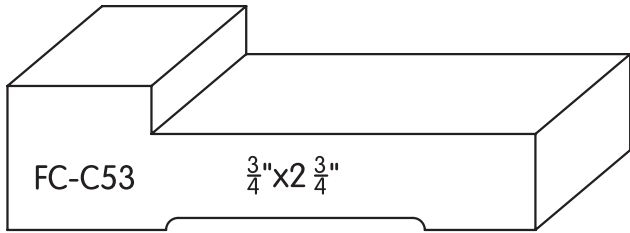

← Available in any width →

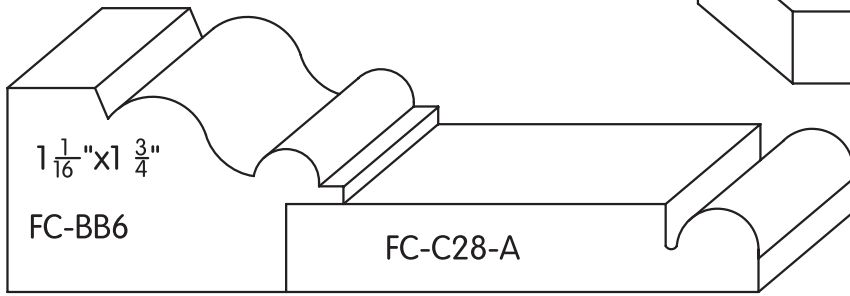
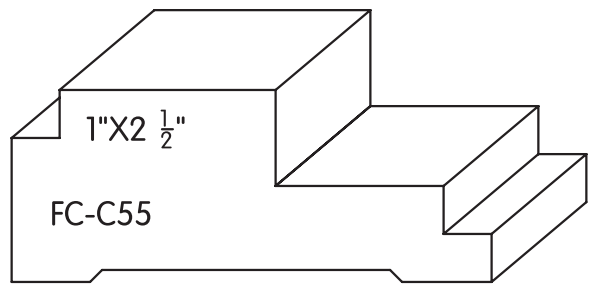

← Available in any width →

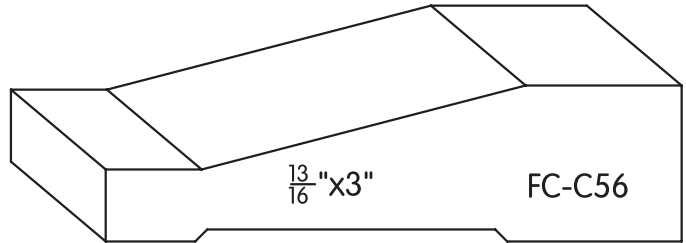

← Available in any width →

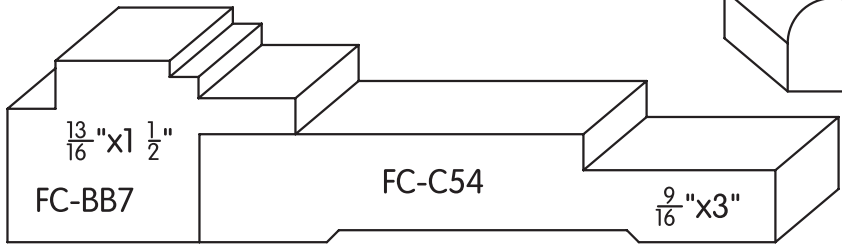

← Available in any width →

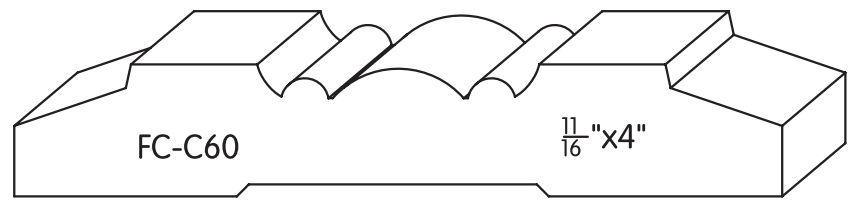
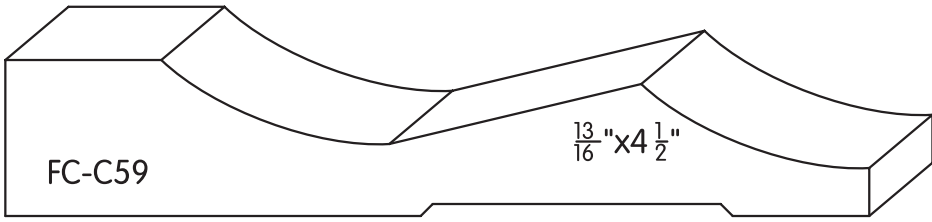
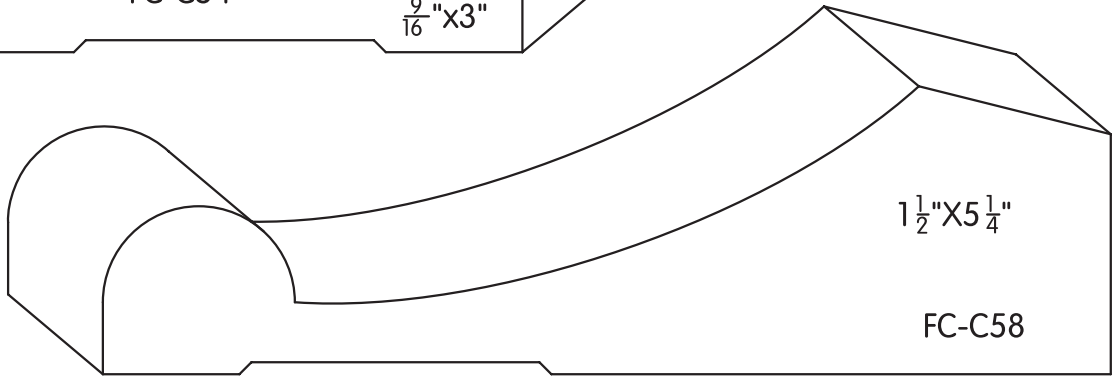
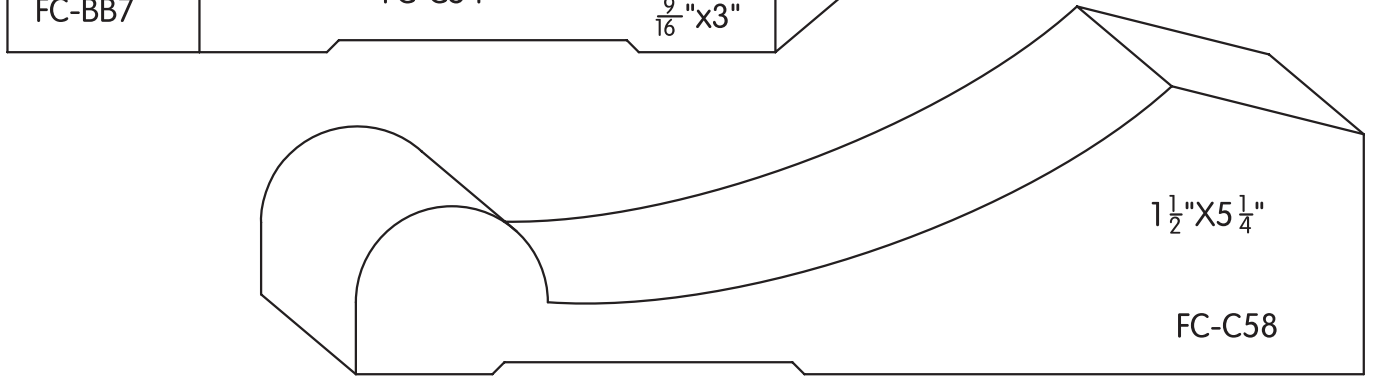
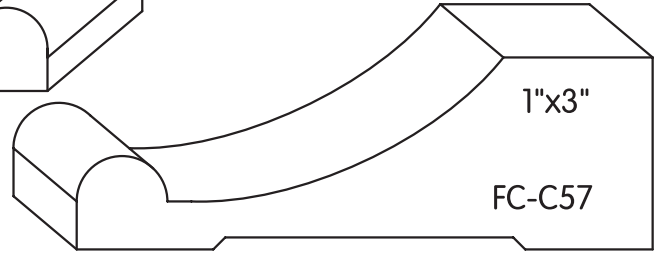

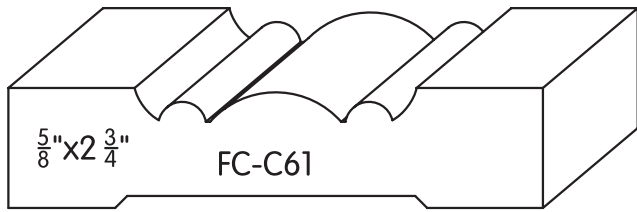

5/8" x 2 3/4"

FC-C61

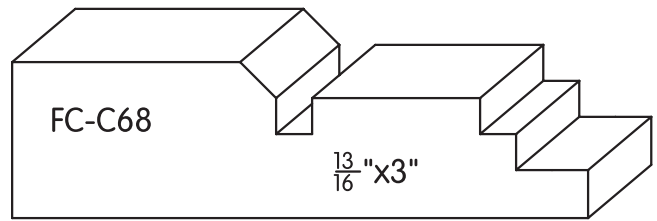

FC-C68

13/16" x 3"

← Available in any width

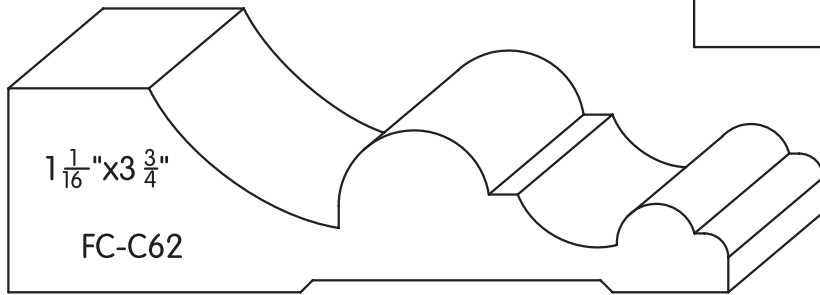

1 1/16" x 3 3/4"

FC-C62

← Available in any width

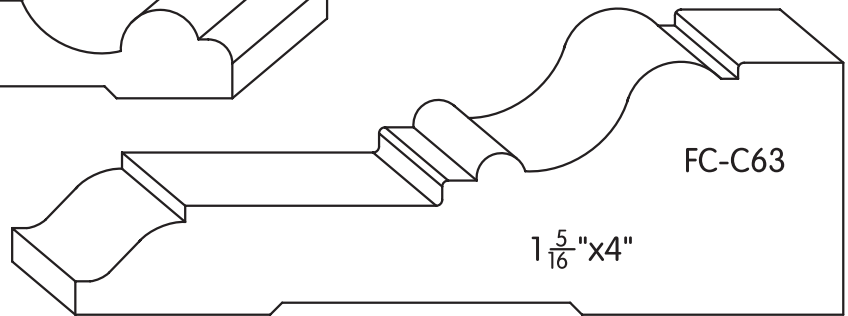

FC-C63

1 5/16" x 4"

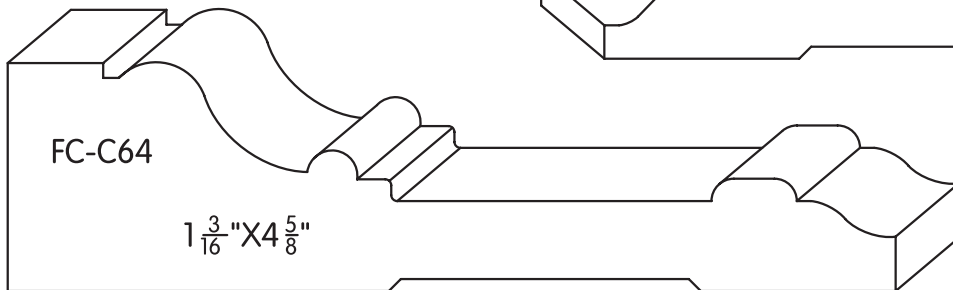

FC-C64

1 3/16" x 4 5/8"

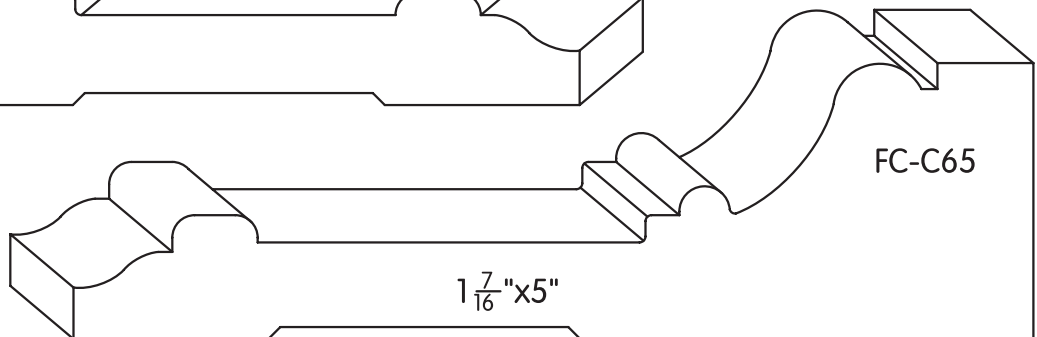

FC-C65

1 7/16" x 5"

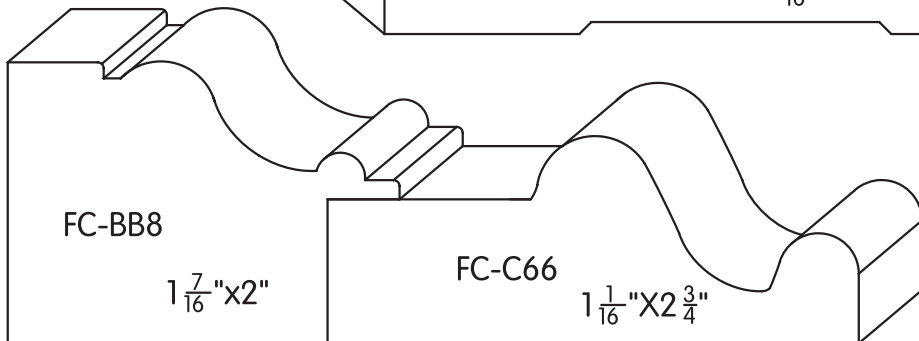

FC-BB8

1 7/16" x 2"

FC-C66

1 1/16" x 2 3/4"

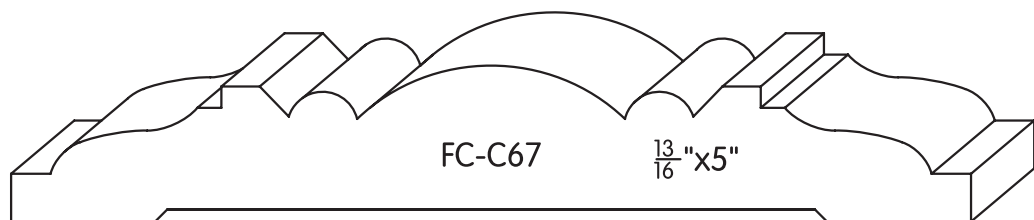

FC-C67

13/16" x 5"



All profiles shown $\frac{3}{4}'' \times 5 \frac{1}{2}''$

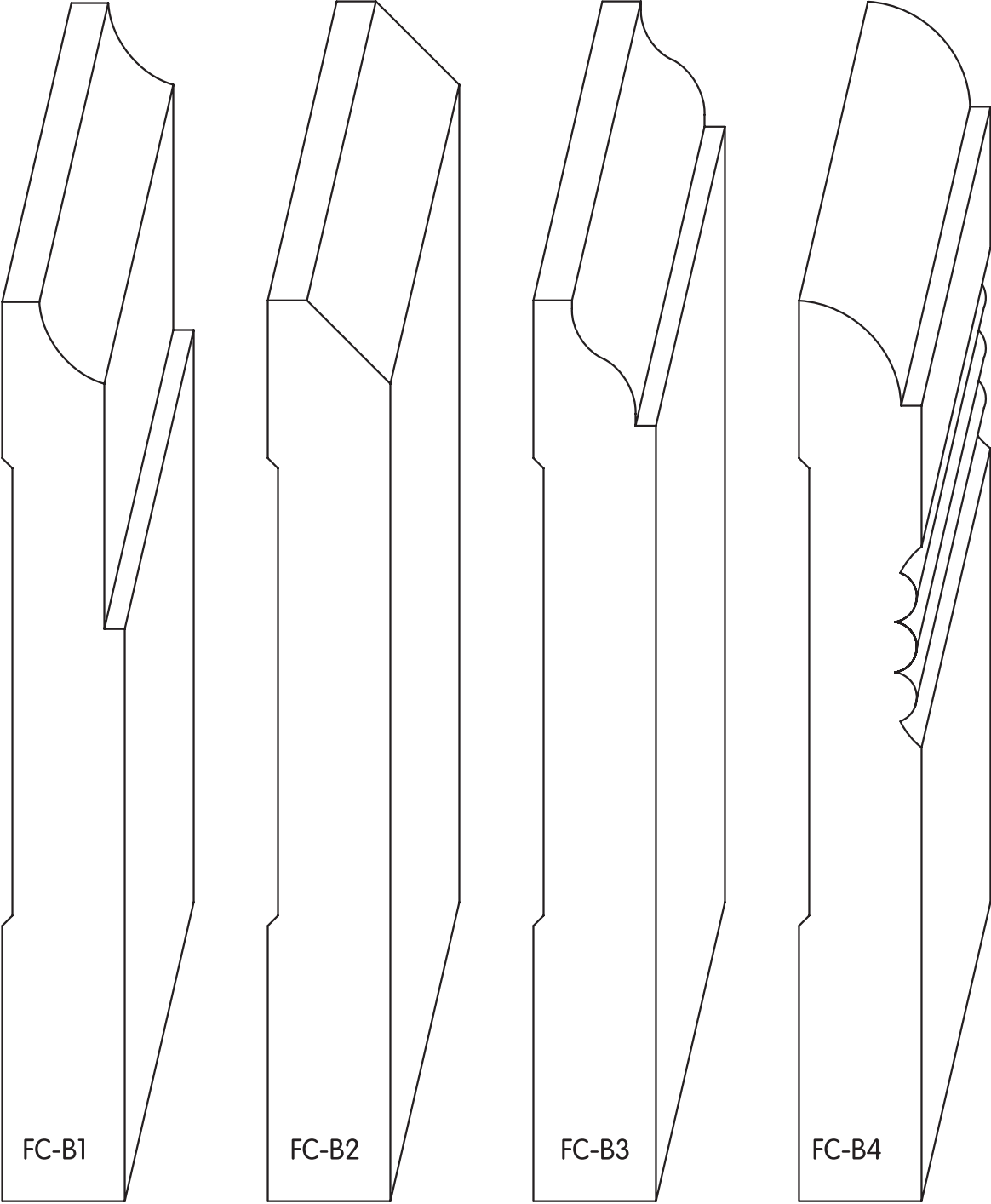

Base Moldings can be made in various thickness and height (up to $8 \frac{1}{2}''$ tall)



All profiles shown $\frac{3}{4}$ " x $5\frac{1}{2}$ "

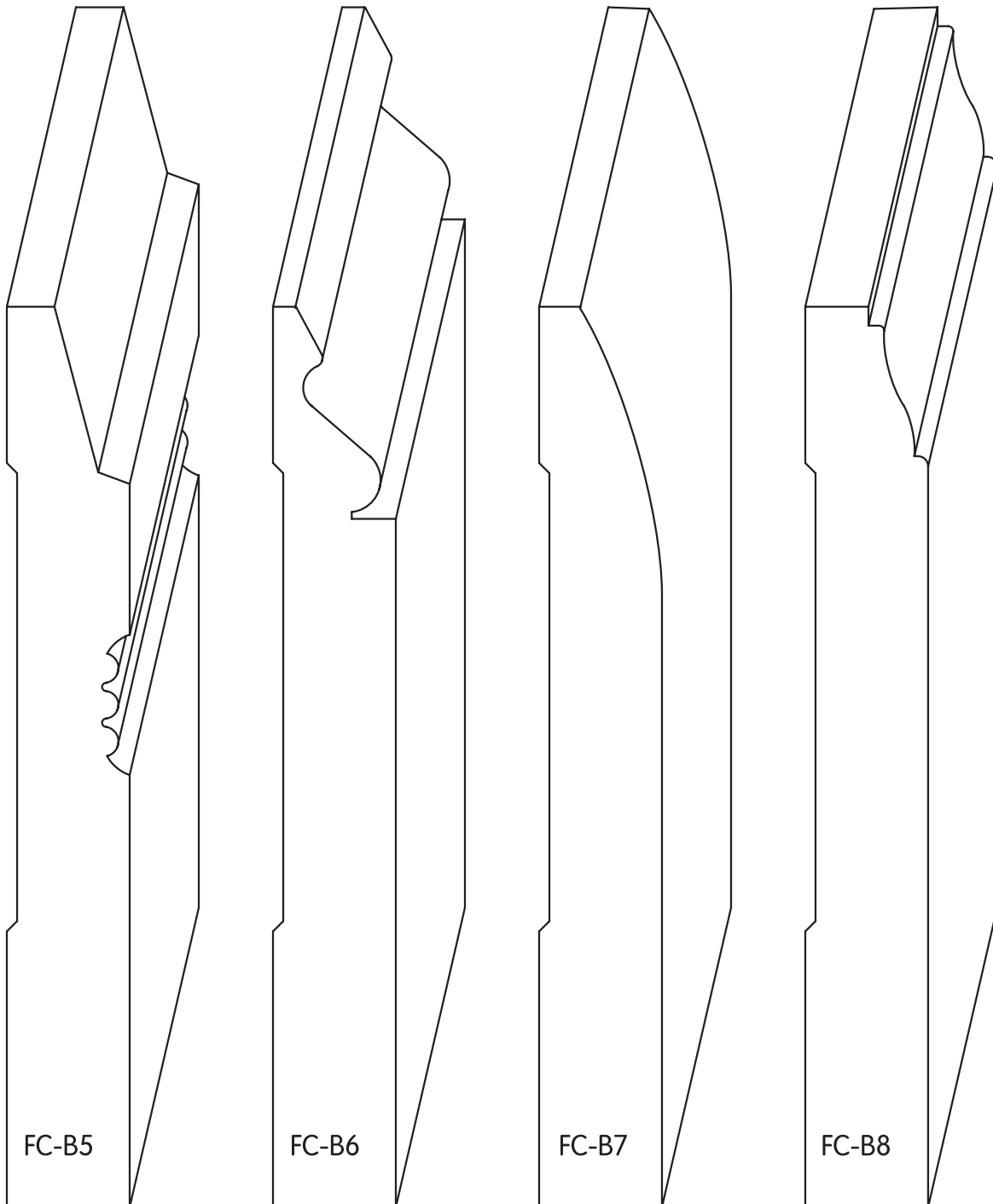

Base Moldings can be made in various thickness and height (up to $8\frac{1}{2}$ " tall)

All profiles shown $\frac{3}{4}'' \times 5\frac{1}{2}''$

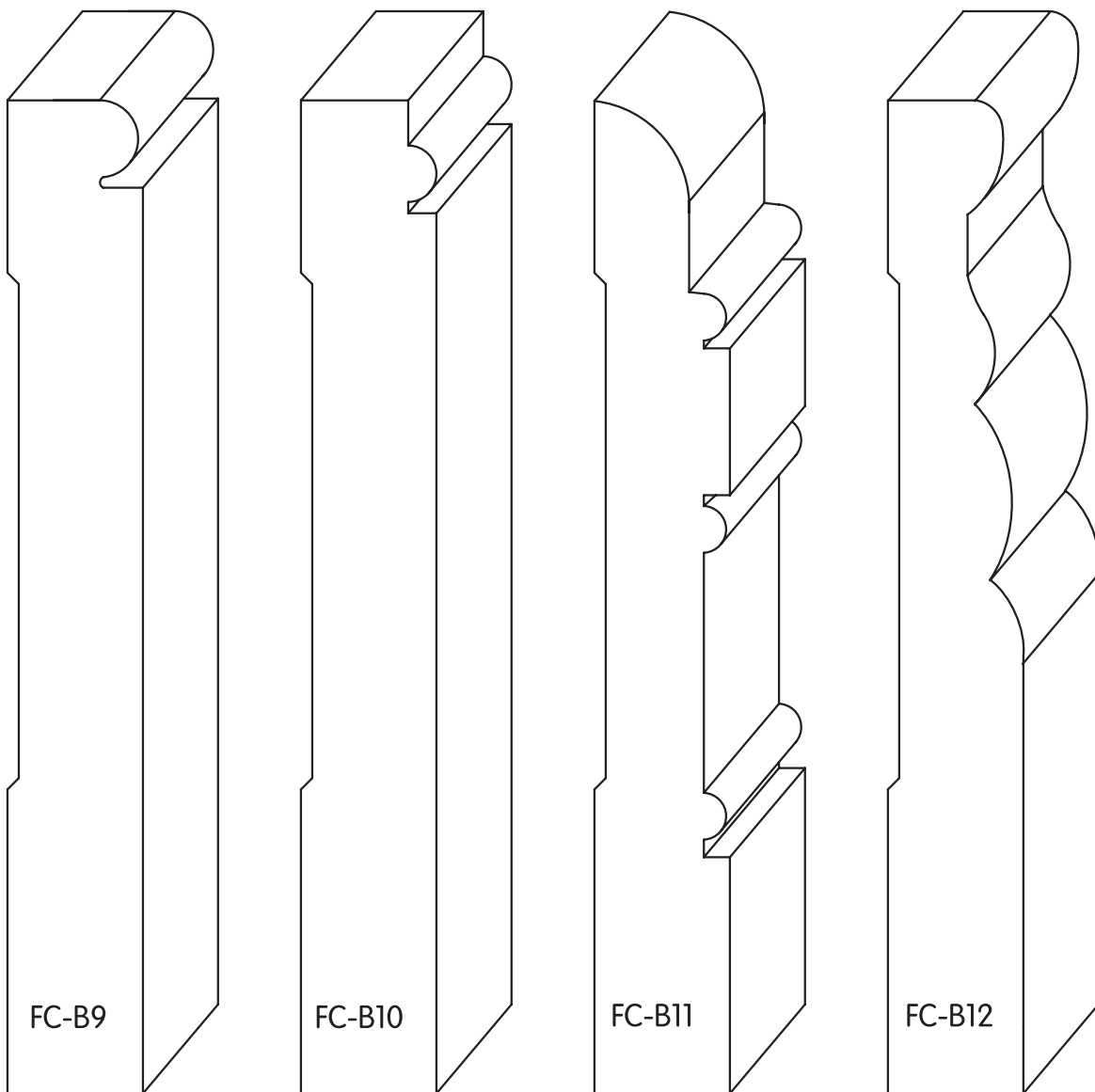

Base Moldings can be made in various thickness and height (up to $8\frac{1}{2}''$ tall)

All profiles shown $\frac{3}{4}$ " x $5\frac{1}{2}$ "

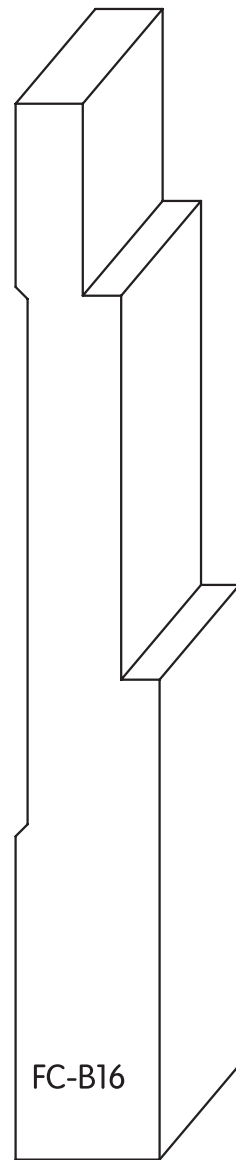
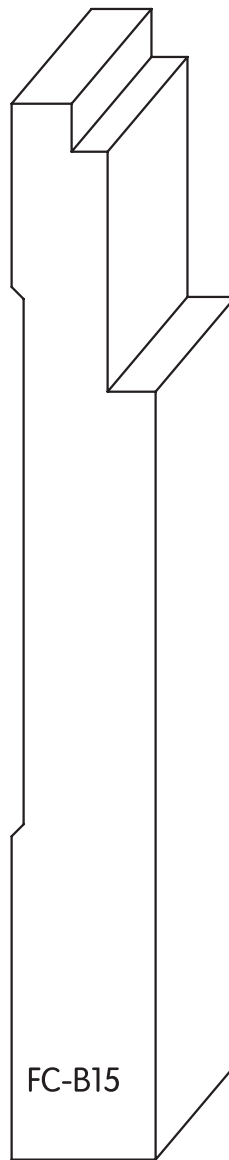
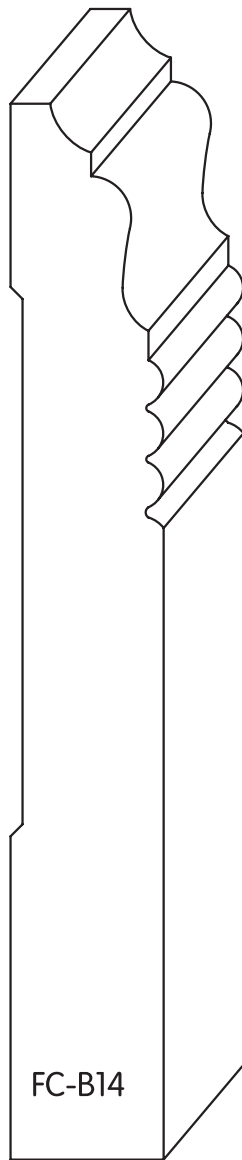
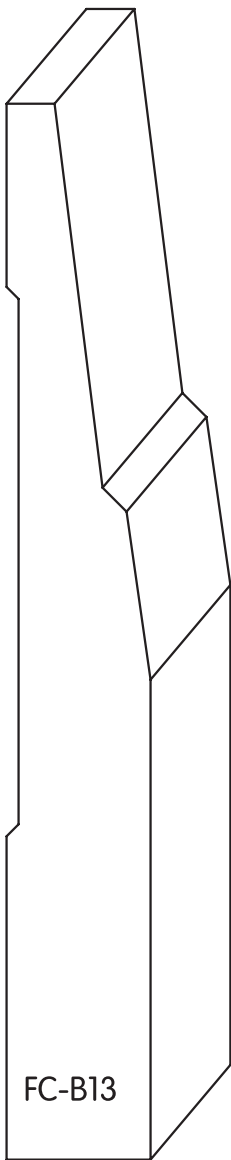

Base Moldings can be made in various thickness and height (up to $8\frac{1}{2}$ " tall)



All profiles shown $\frac{3}{4}$ " x $5\frac{1}{2}$ "

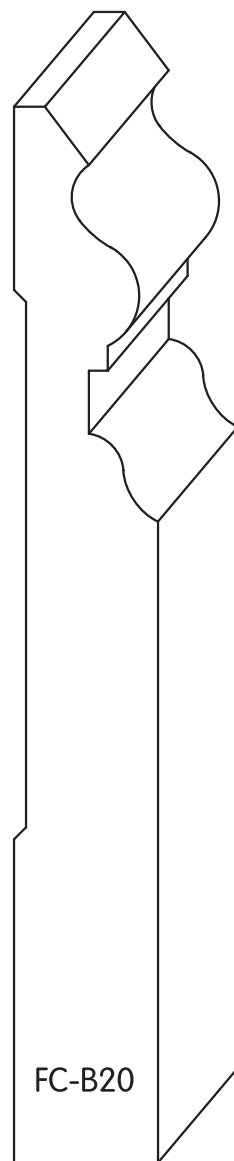
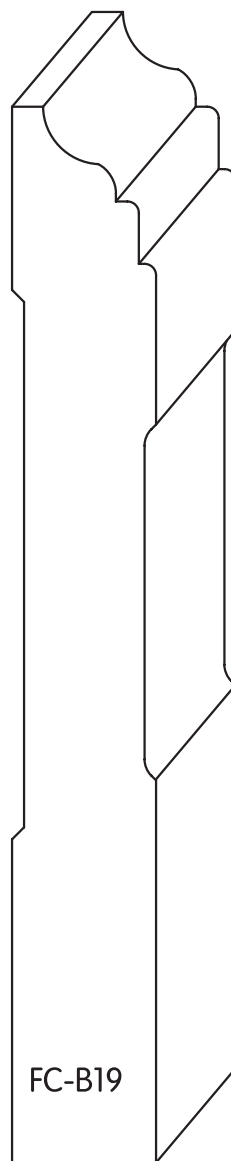
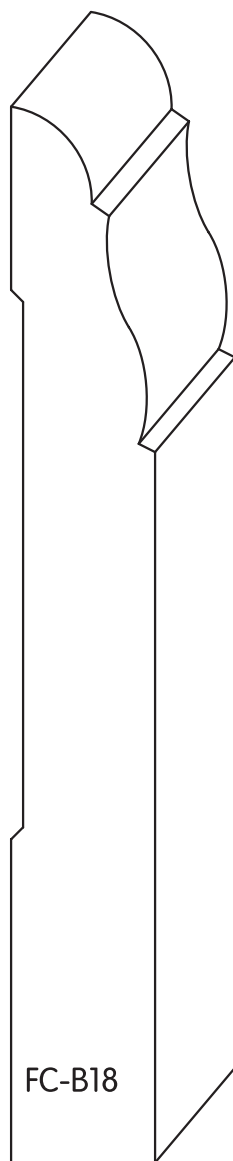
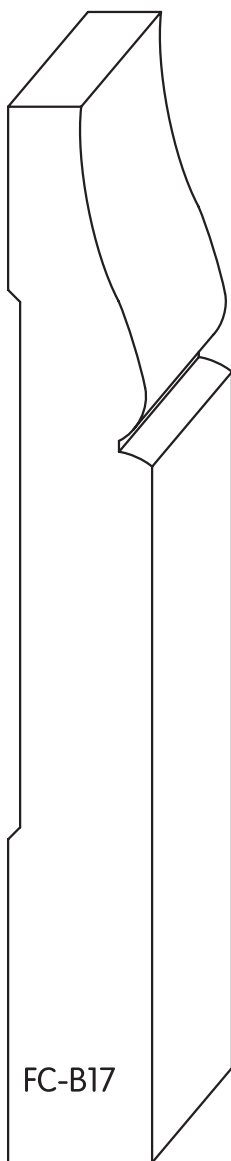

Base Moldings can be made in various thickness and height (up to $8\frac{1}{2}$ " tall)



All profiles shown $\frac{3}{4}$ " x $5\frac{1}{2}$ "

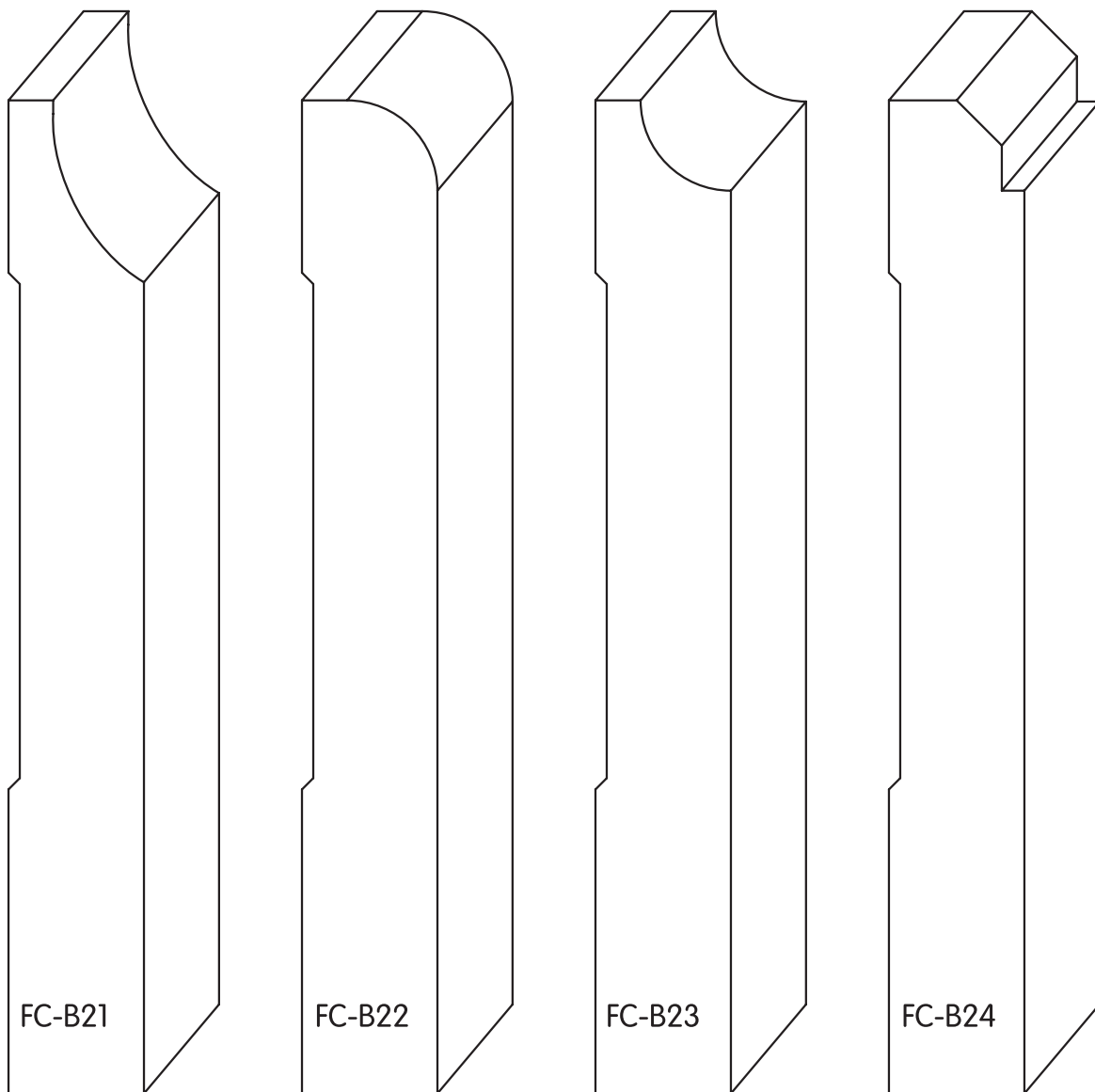

Base Moldings can be made in various thickness and height (up to $8\frac{1}{2}$ " tall)



All profiles shown $\frac{3}{4}" \times 5\frac{1}{2}"$

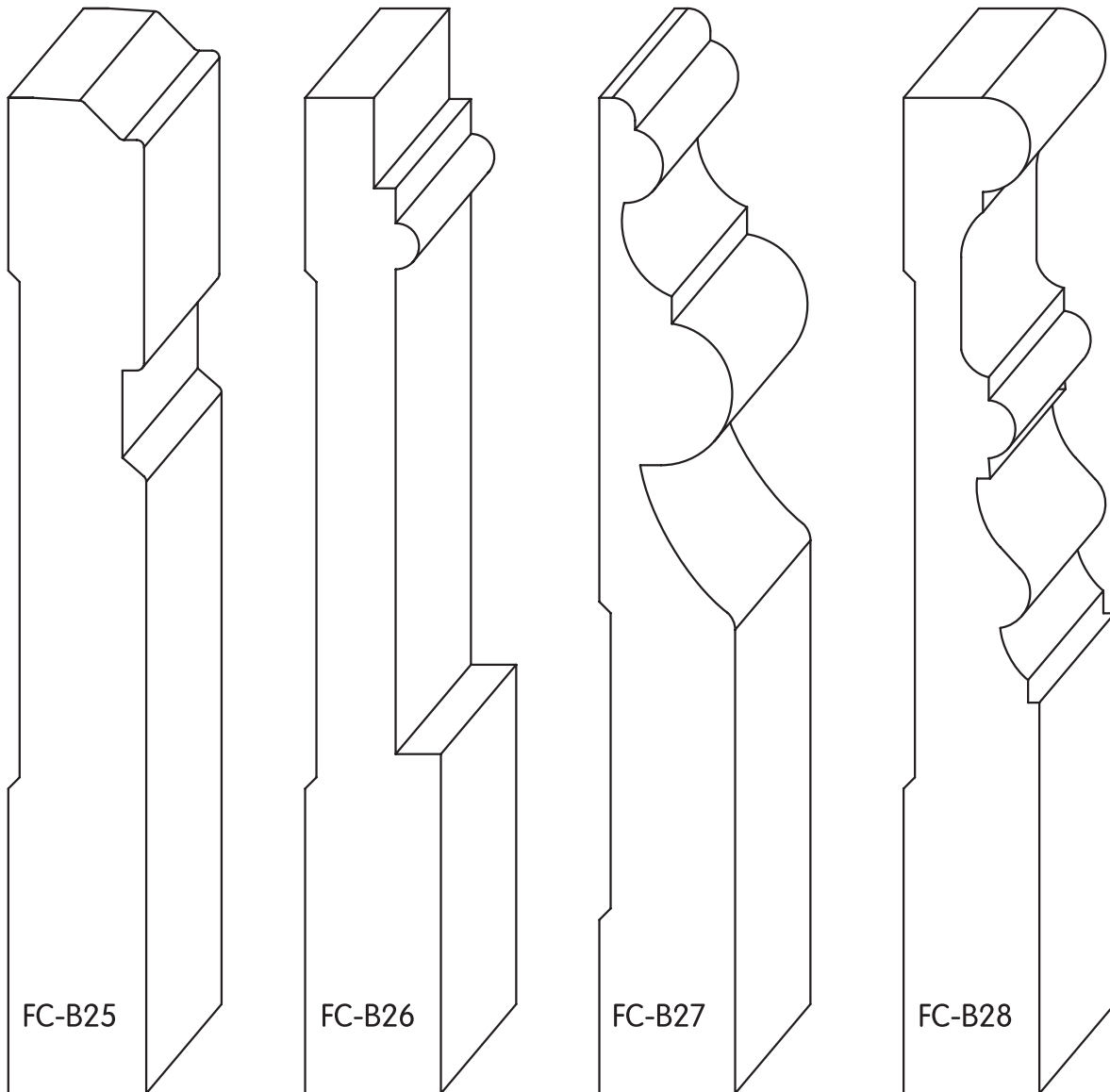

Base Moldings can be made in various thickness and height (up to $8\frac{1}{2}"$ tall)



All profiles shown $\frac{3}{4}$ " x $5\frac{1}{2}$ "

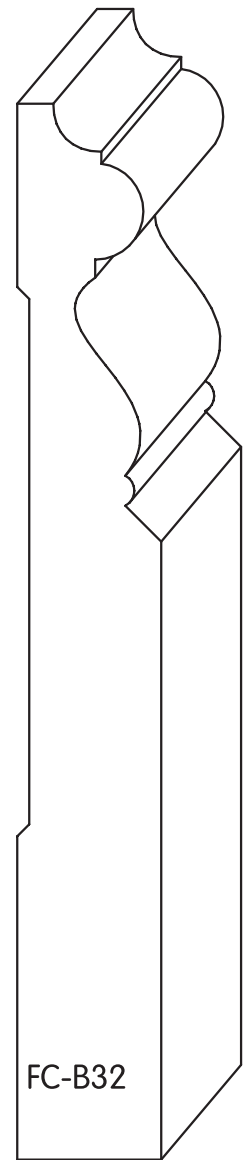
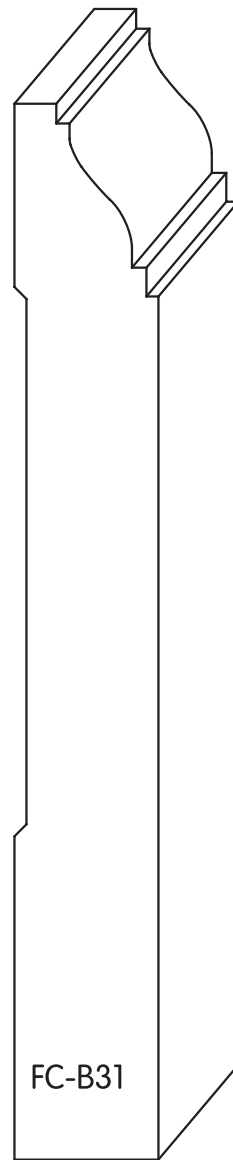
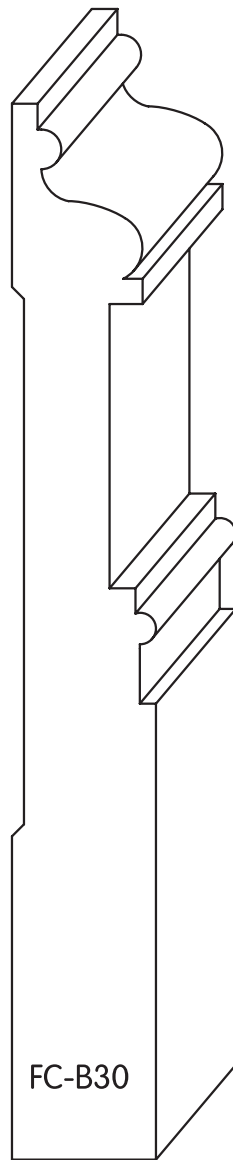
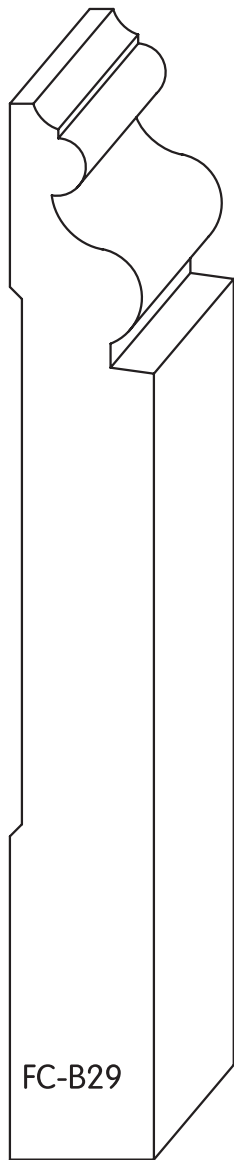

Base Moldings can be made in various thickness and height (up to $8\frac{1}{2}$ " tall)



All profiles shown $\frac{3}{4}$ " x $5\frac{1}{2}$ "

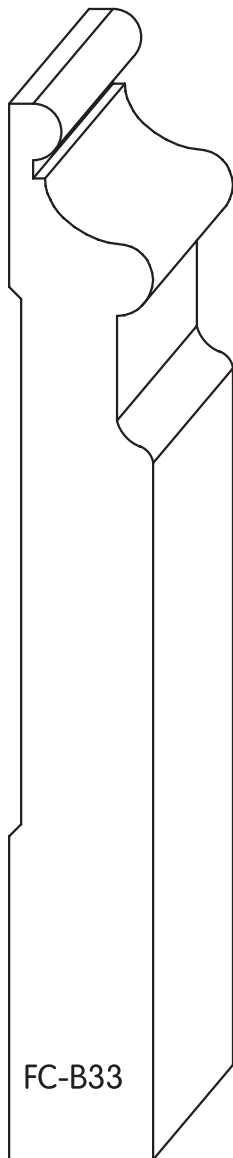

FC-B33

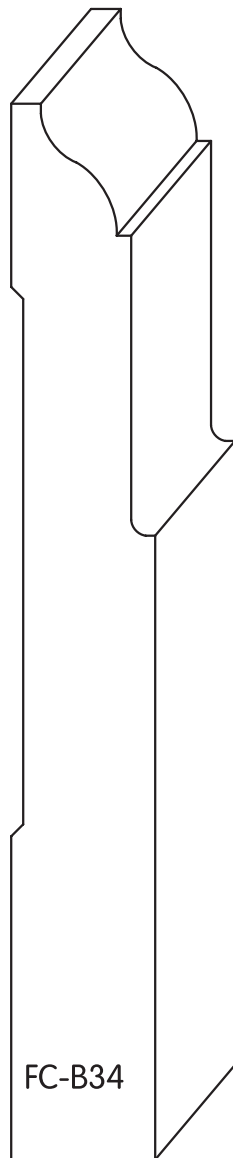

FC-B34

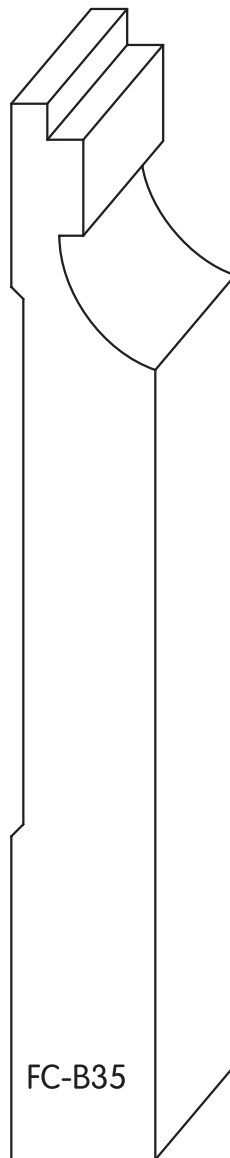

FC-B35

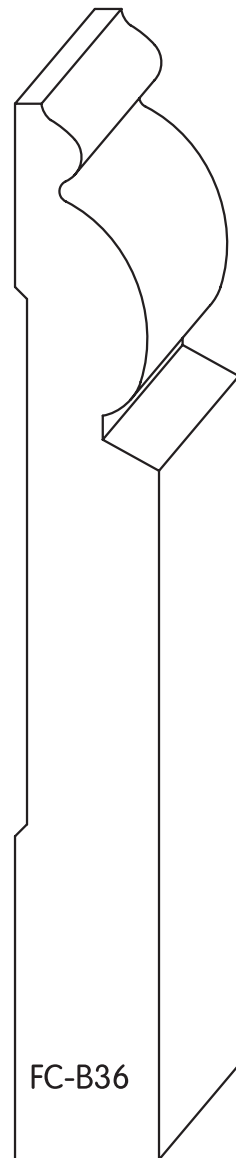

FC-B36

Base Moldings can be made in various thickness and height (up to $8\frac{1}{2}$ " tall)

All profiles shown $\frac{3}{4}$ " x $5\frac{1}{2}$ "

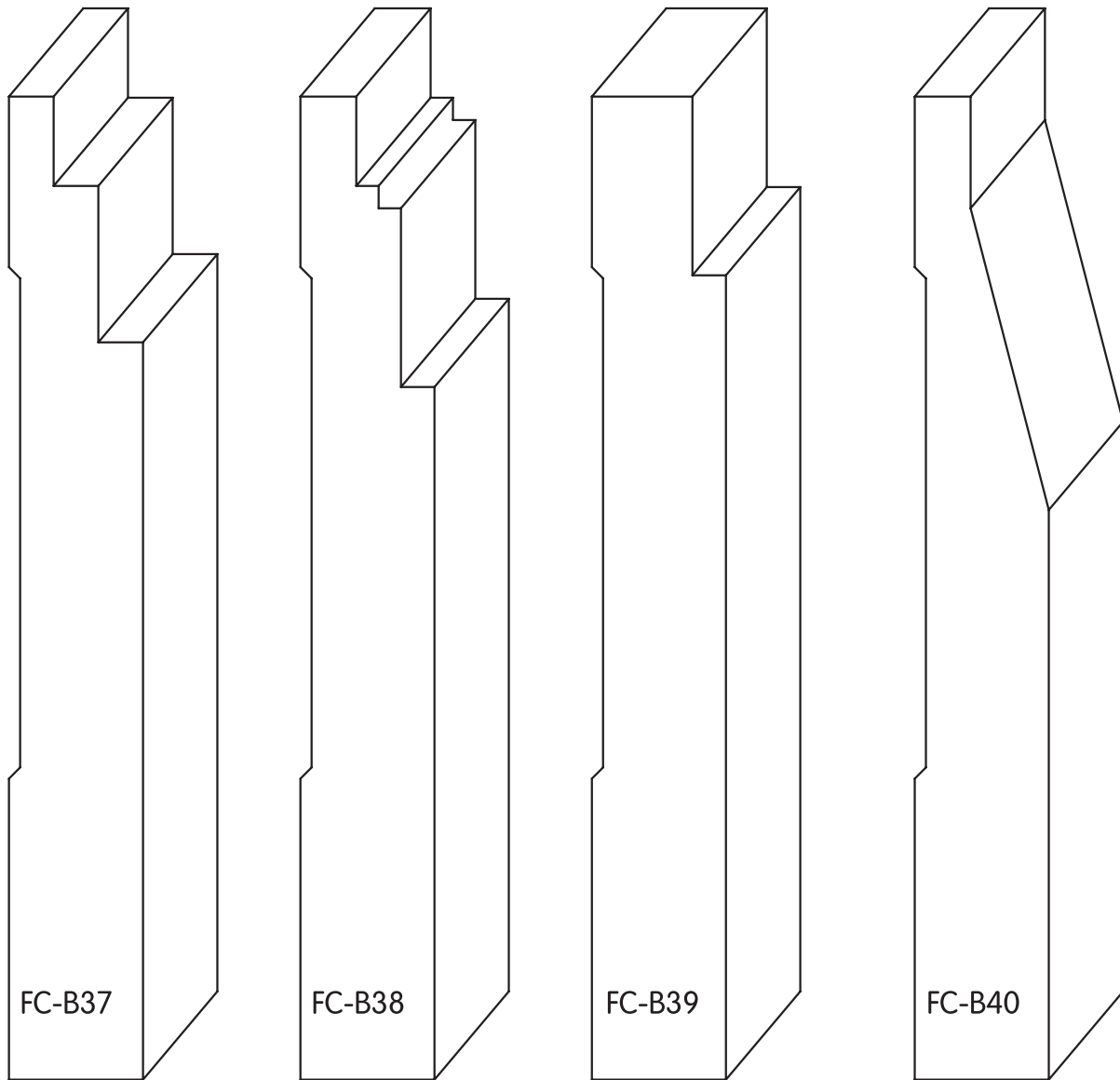

Base Moldings can be made in various thickness and height (up to $8\frac{1}{2}$ " tall)



All profiles shown $\frac{3}{4}$ "x $5\frac{1}{2}$ "

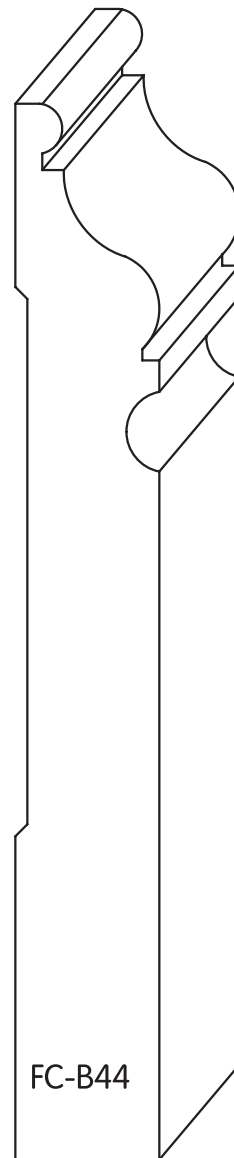
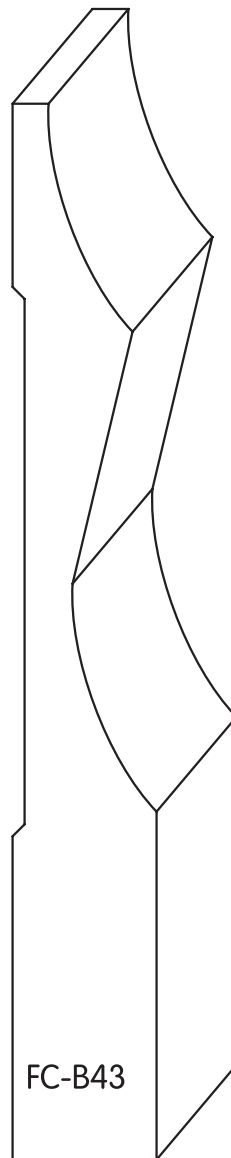
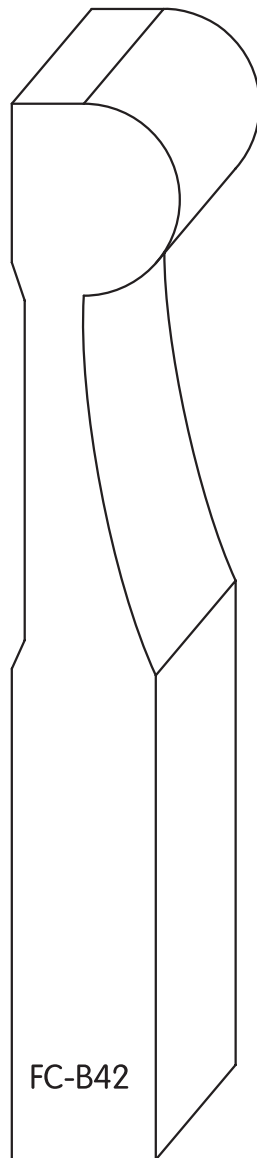
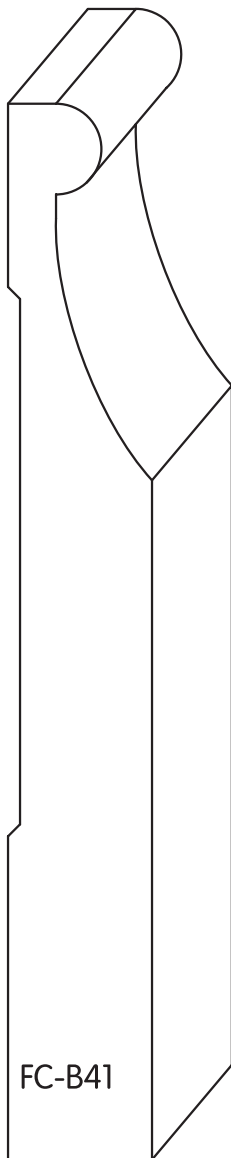

Base Moldings can be made in various thickness and height (up to $8\frac{1}{2}$ " tall)



All profiles shown $\frac{3}{4}$ " x $5\frac{1}{2}$ "

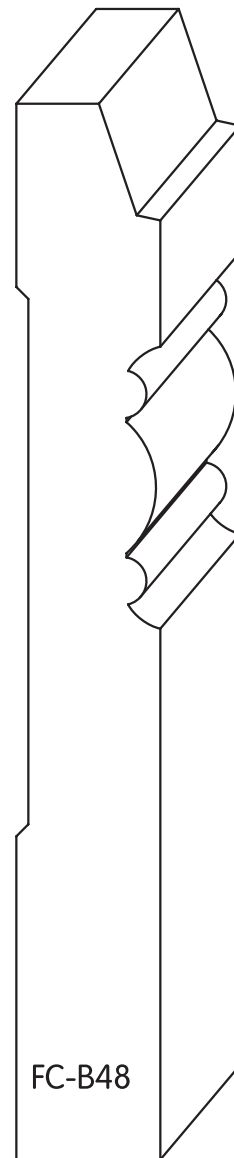
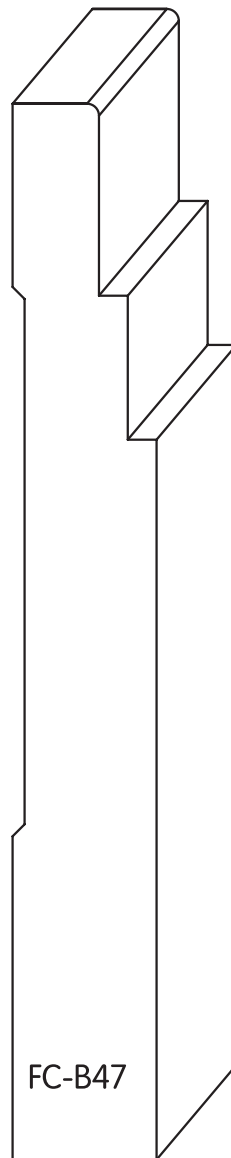
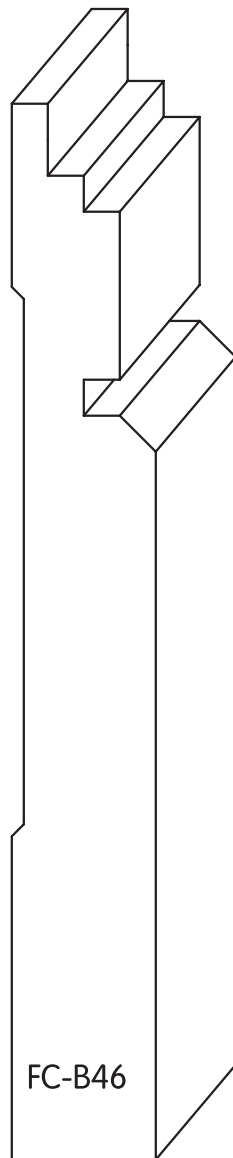
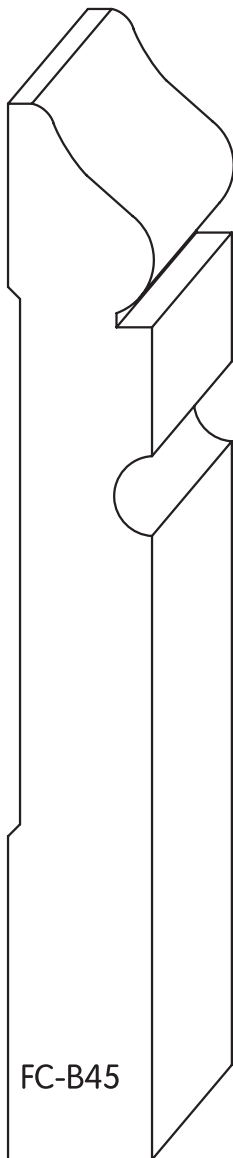

Base Moldings can be made in various thickness and height (up to $8\frac{1}{2}$ " tall)



All profiles shown $\frac{3}{4}'' \times 5 \frac{1}{2}''$

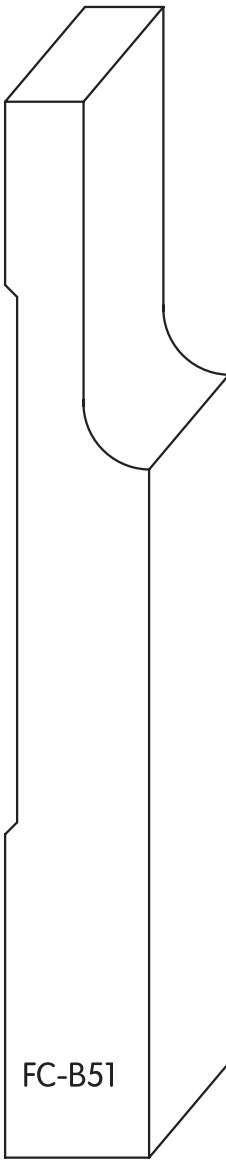
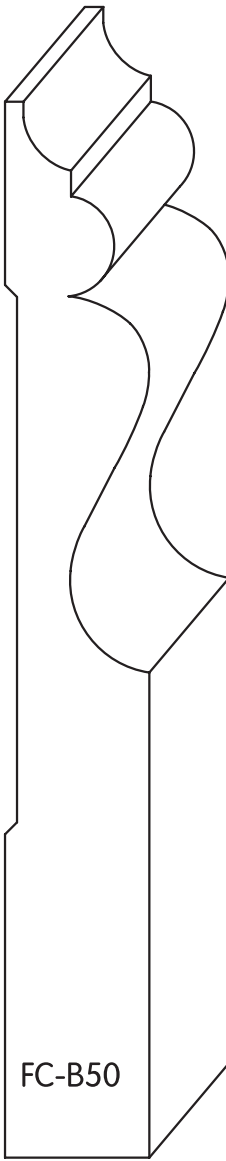
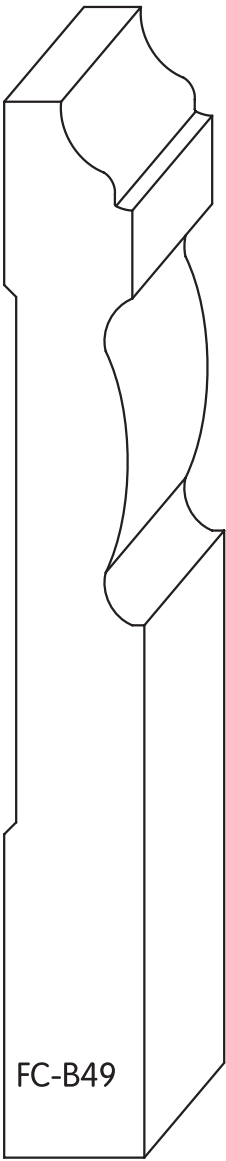

Base Moldings can be made in various thickness and height (up to $8 \frac{1}{2}''$ tall)



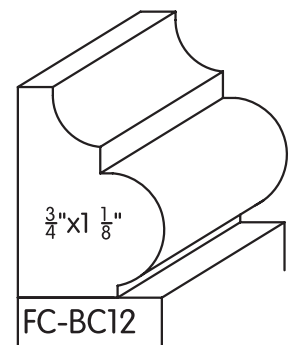
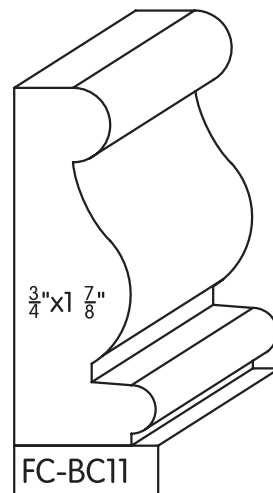
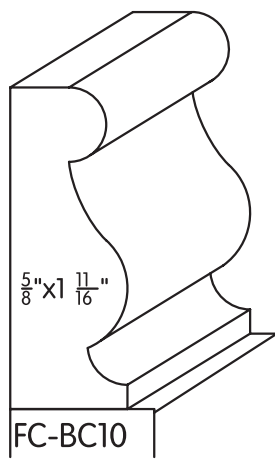
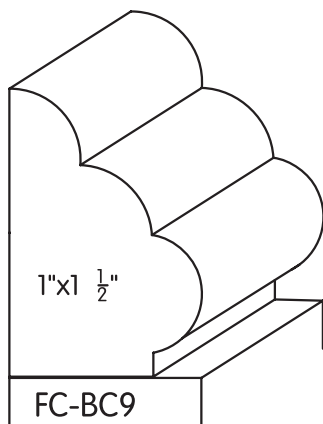
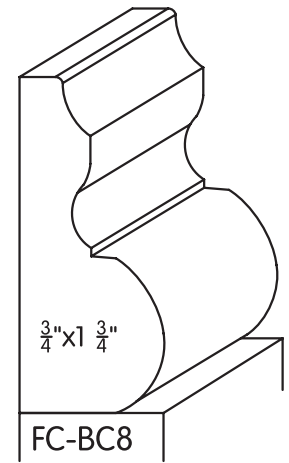
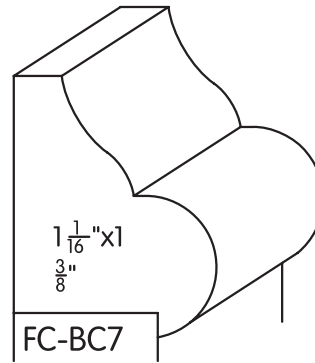
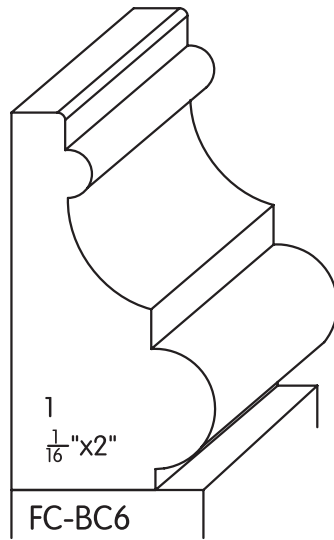
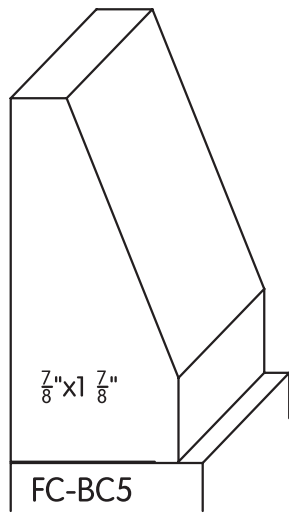
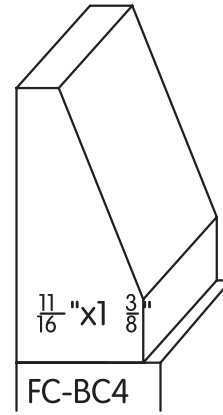
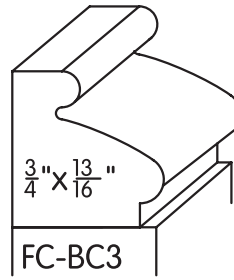
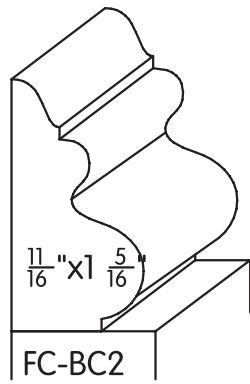
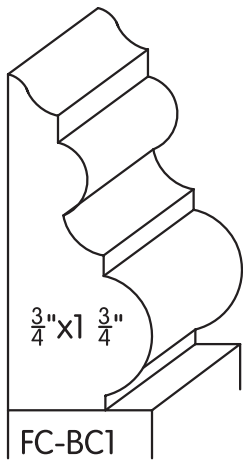

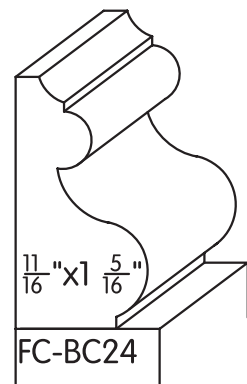
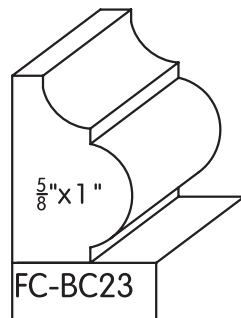
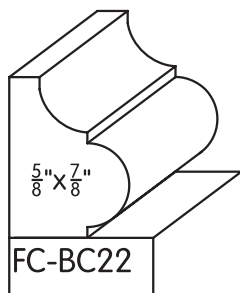
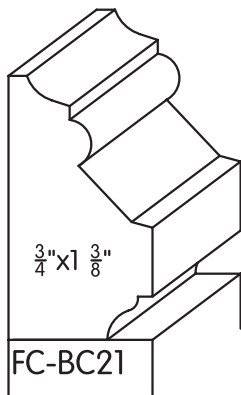
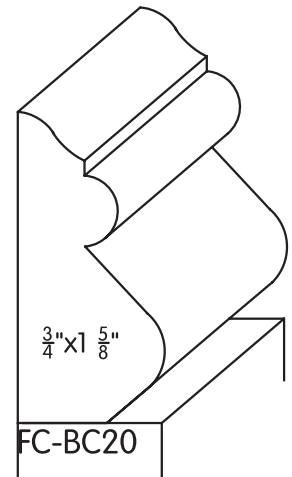
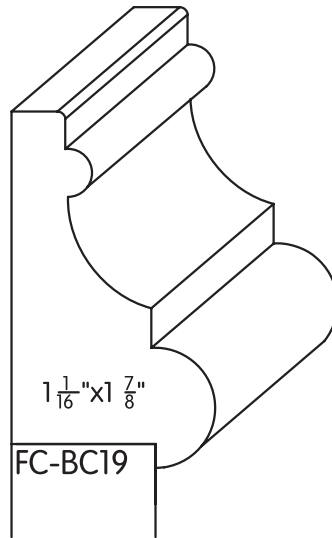
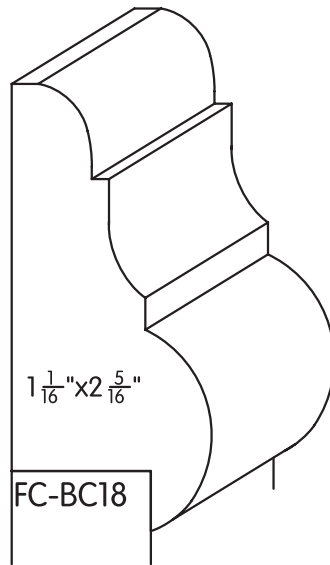
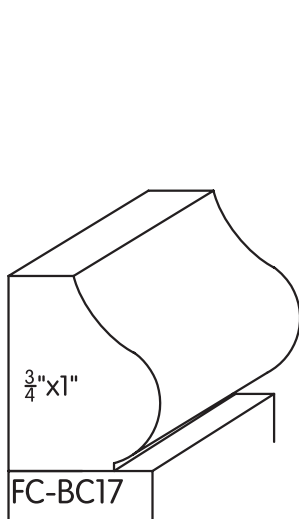
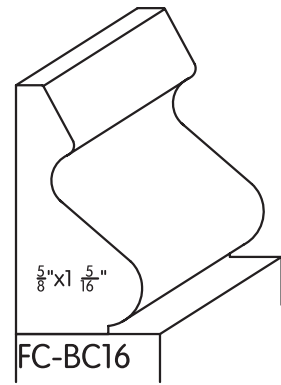
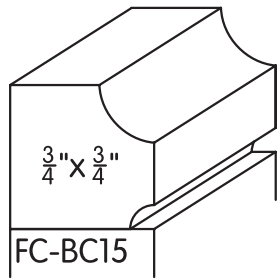
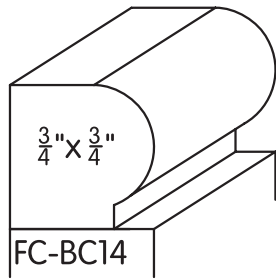
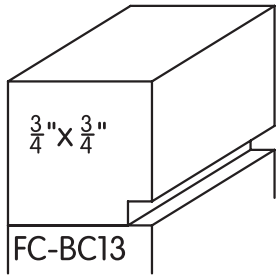

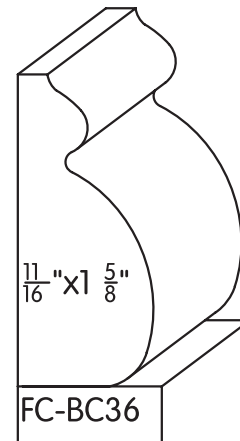
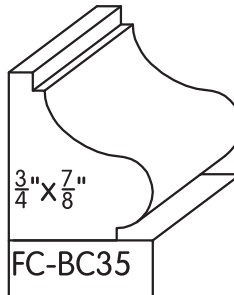
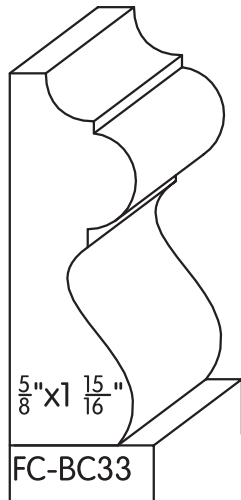
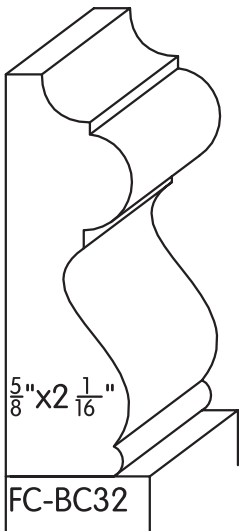
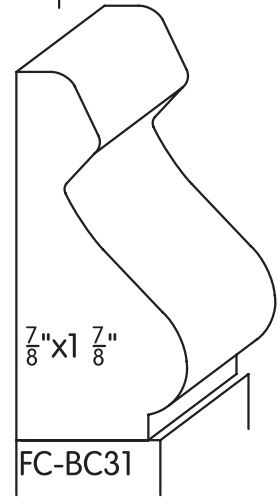
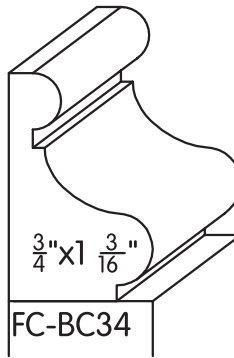
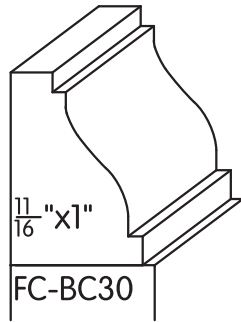
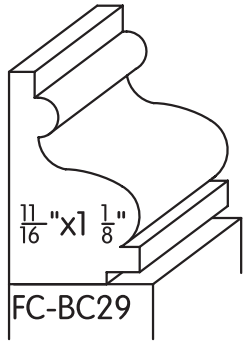
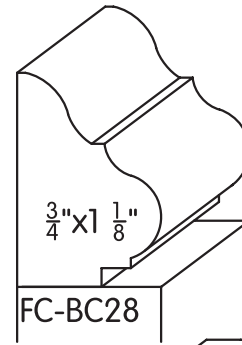
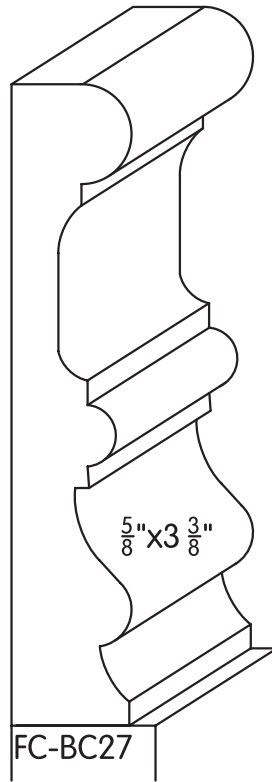
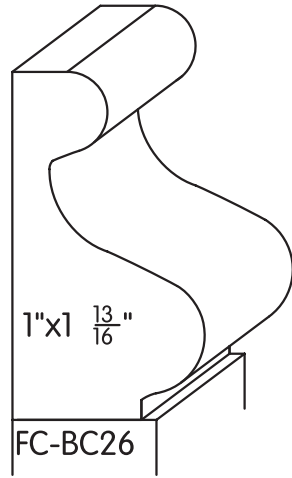
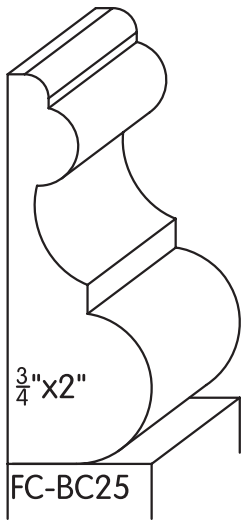

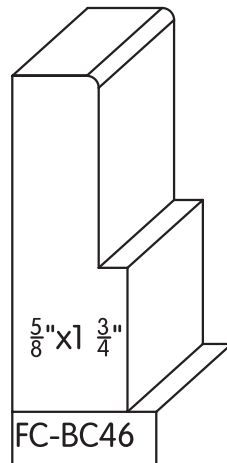
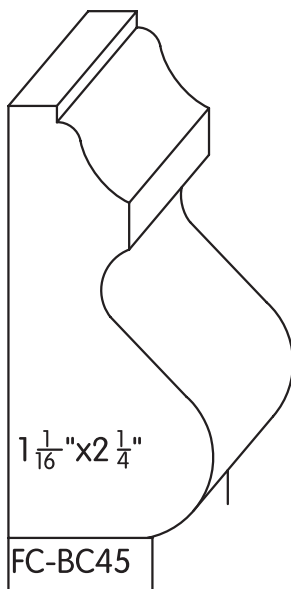
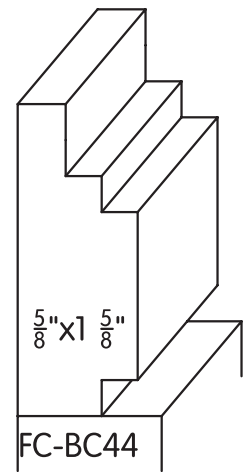
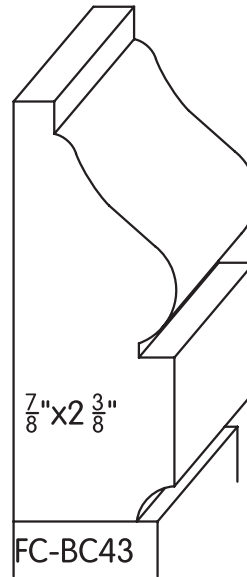
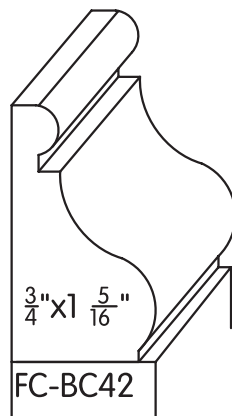
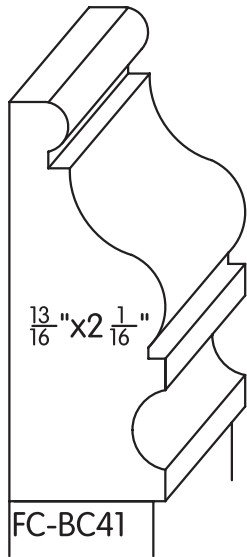
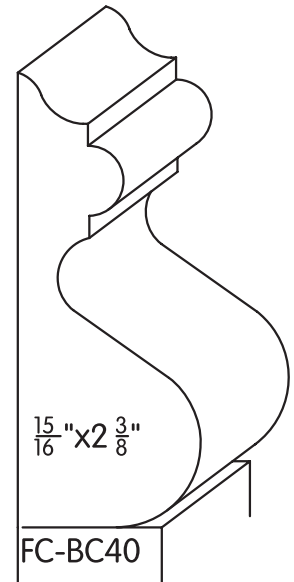
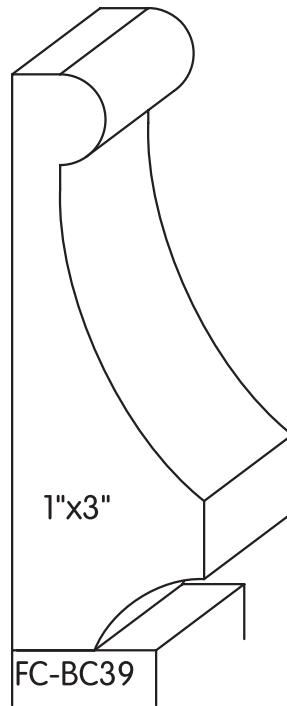
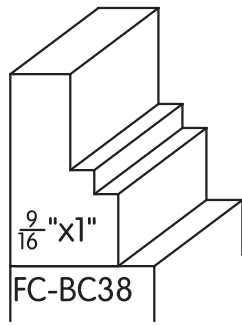
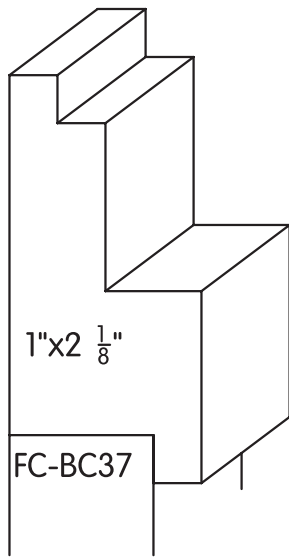

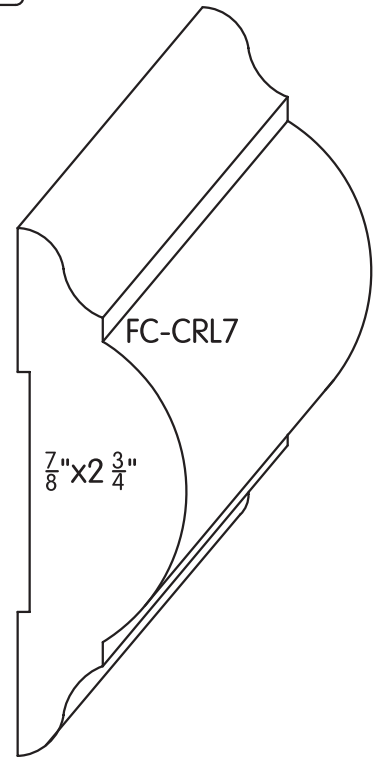
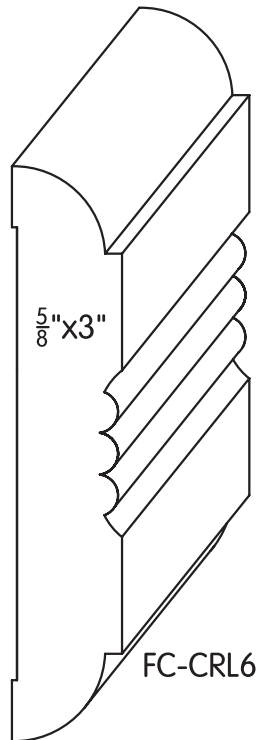
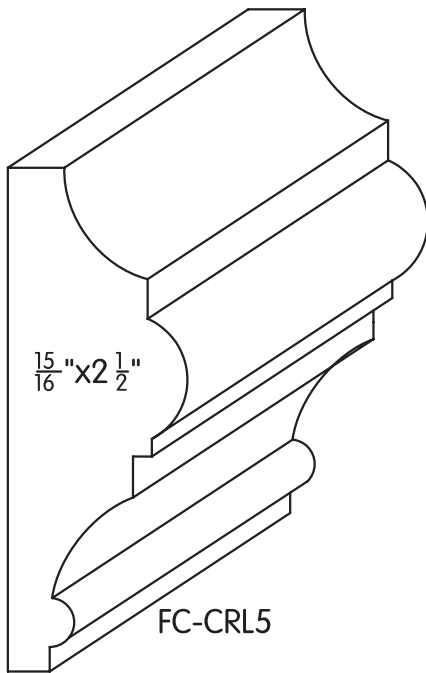
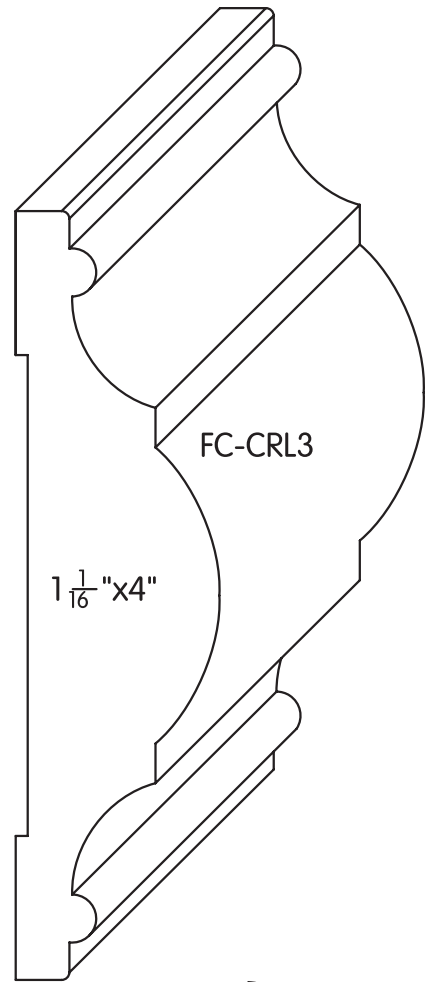
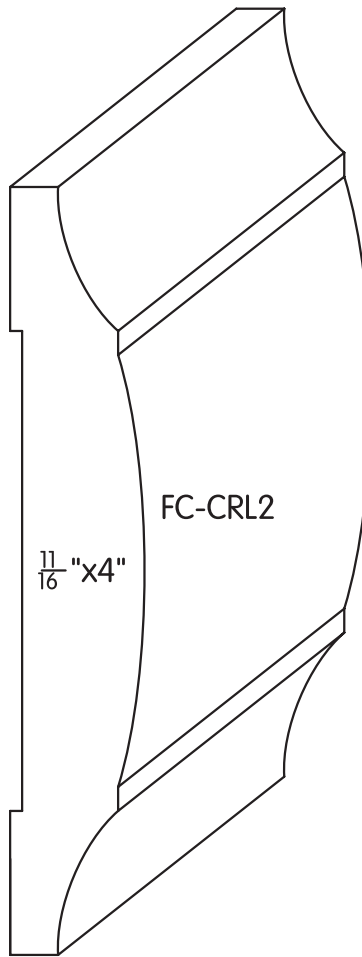
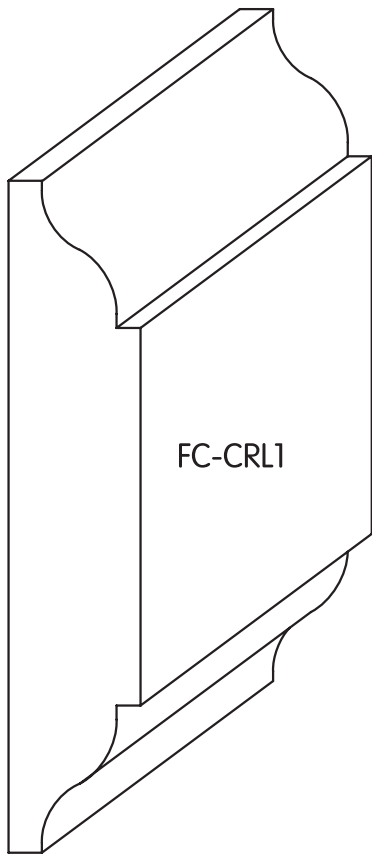

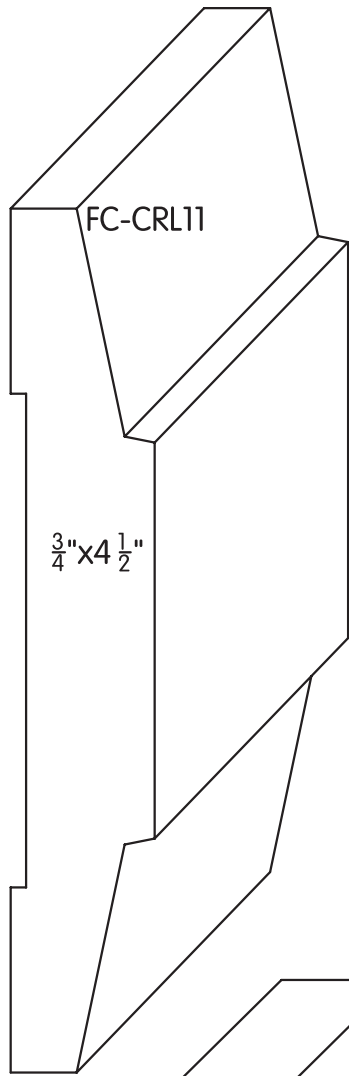

FC-CRL11

$\frac{3}{4}$ " x $4\frac{1}{2}$ "

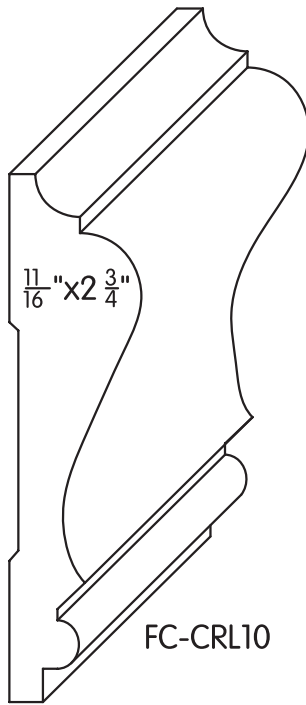

$1\frac{1}{16}$ " x $2\frac{3}{4}$ "

FC-CRL10

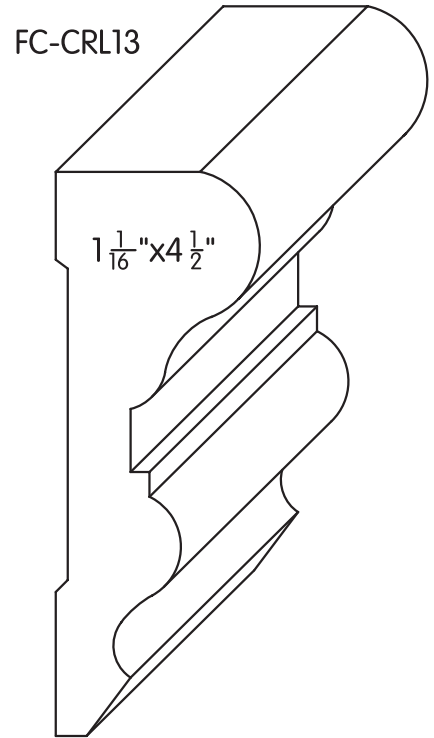

FC-CRL13

$1\frac{1}{16}$ " x $4\frac{1}{2}$ "

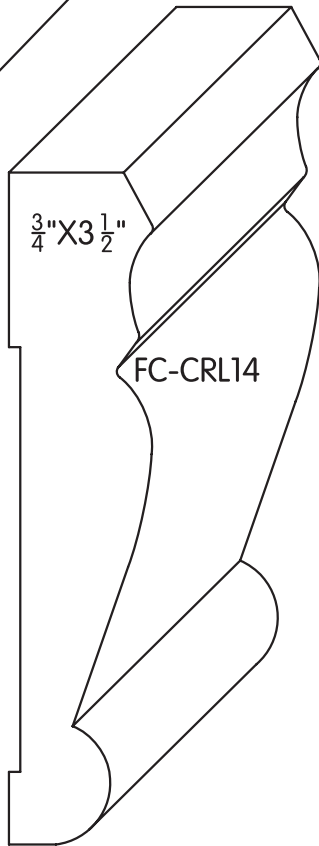

$\frac{3}{4}$ " x $3\frac{1}{2}$ "

FC-CRL14

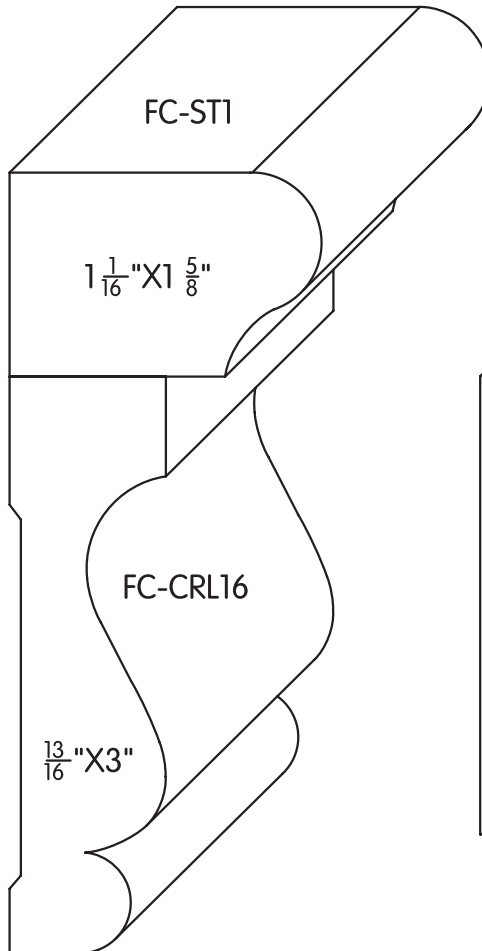

FC-ST1

$1\frac{1}{16}$ " x $1\frac{5}{8}$ "

FC-CRL16

$\frac{13}{16}$ " x 3"

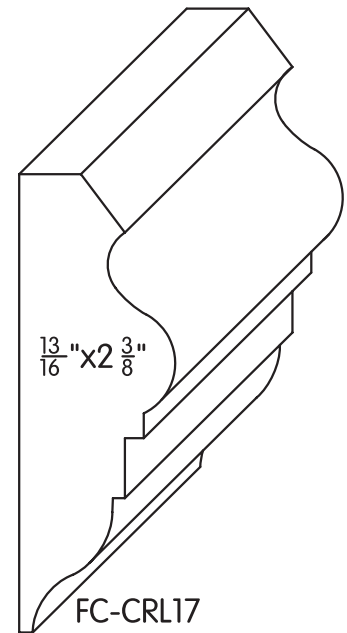

$\frac{13}{16}$ " x $2\frac{3}{8}$ "

FC-CRL17

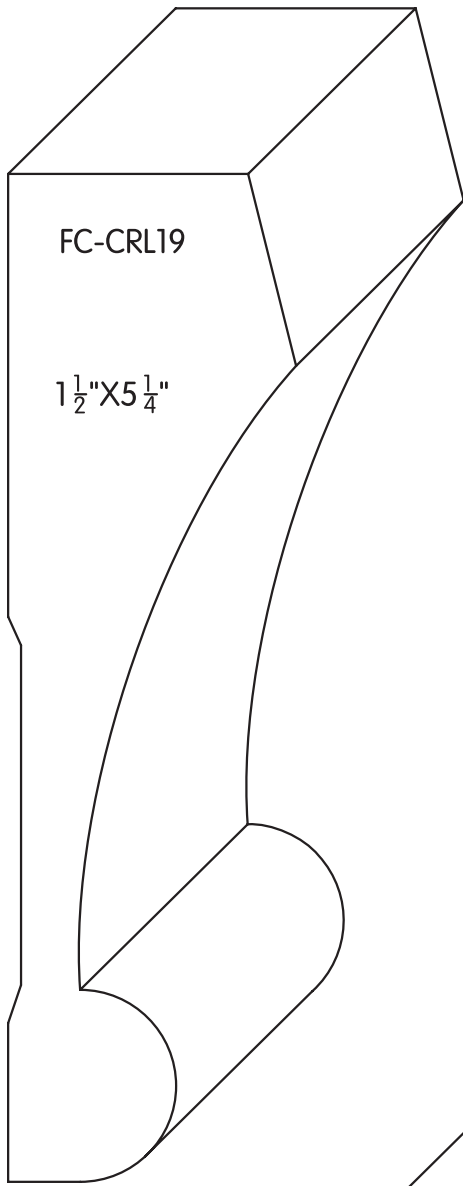

FC-CRL19

1 1/2" x 5 1/4"

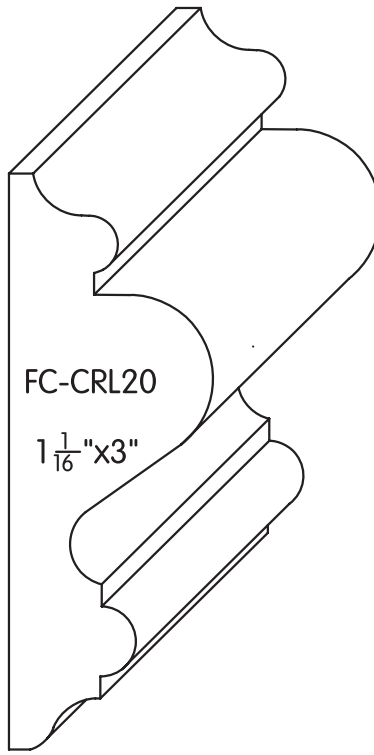

FC-CRL20

1 1/16" x 3"

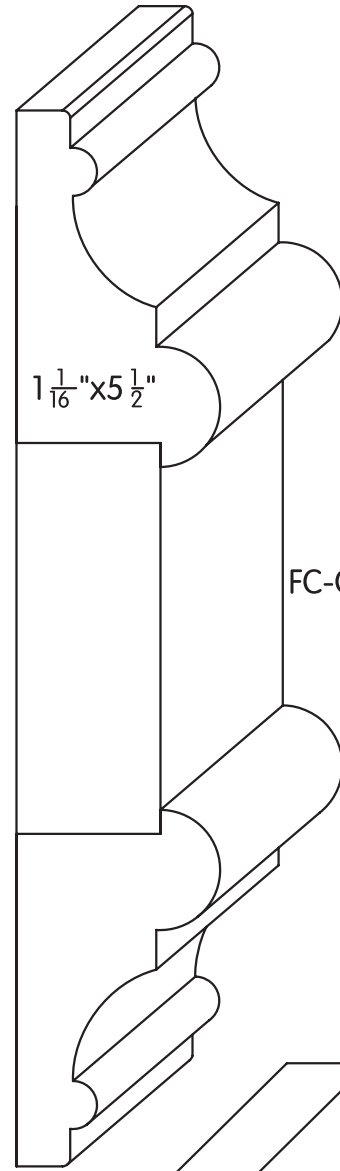

1 1/16" x 5 1/2"

FC-CRL15

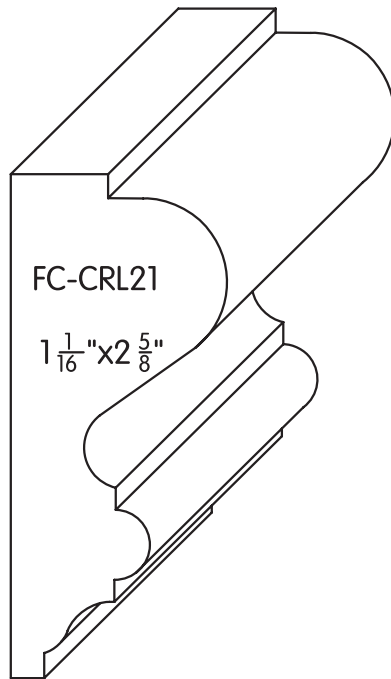

FC-CRL21

1 1/16" x 2 5/8"

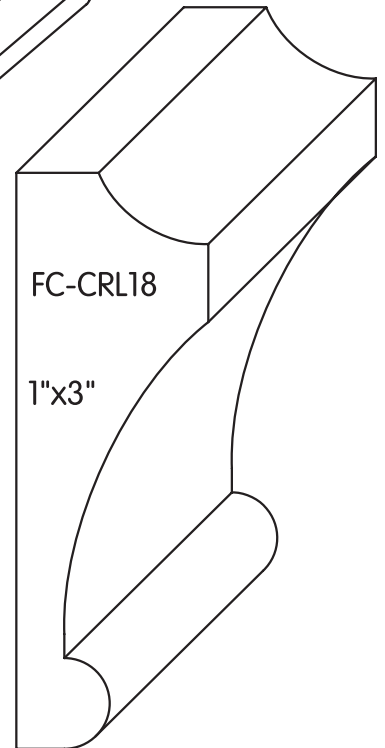

FC-CRL18

1" x 3"

DOOR & GLASS STOPS

Many stops can be milled to custom width.

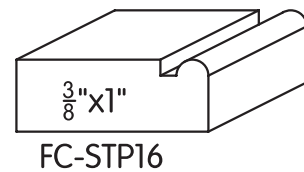
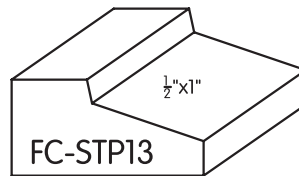
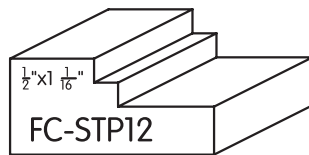
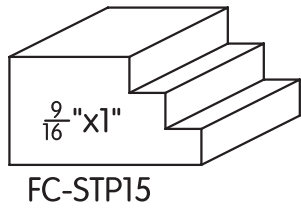
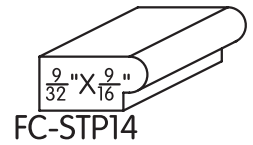
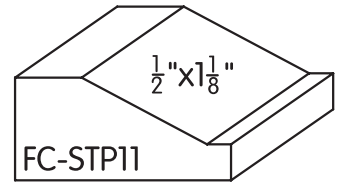
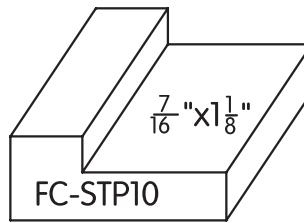
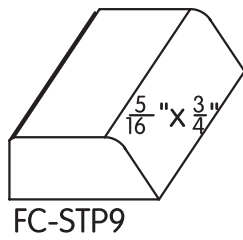
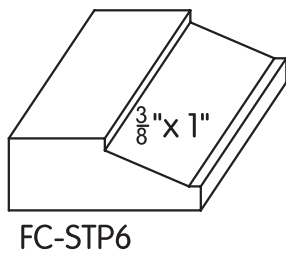
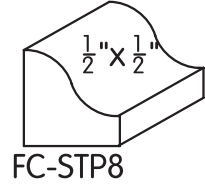
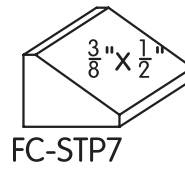
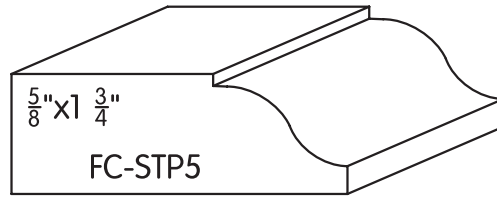
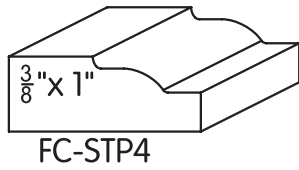
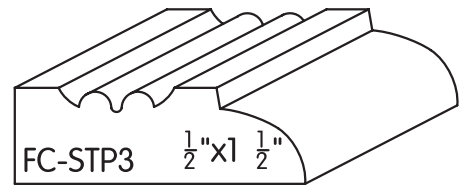
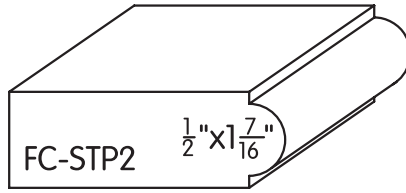
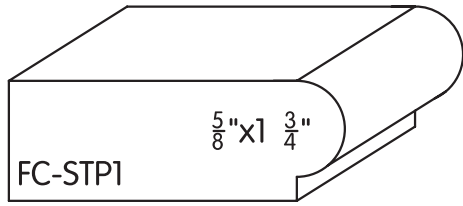

NOSE & COVE

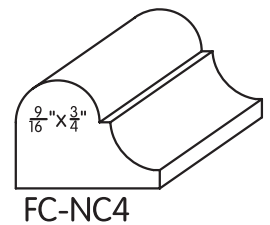
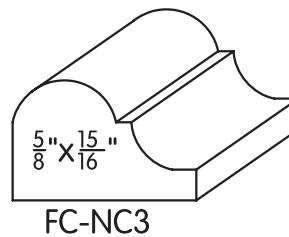
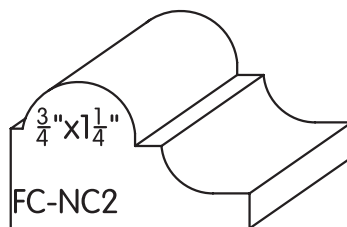
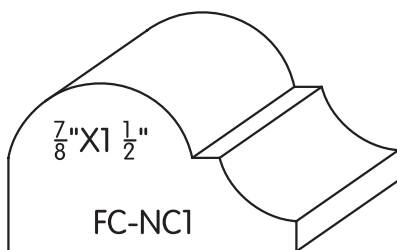

BACKBAND

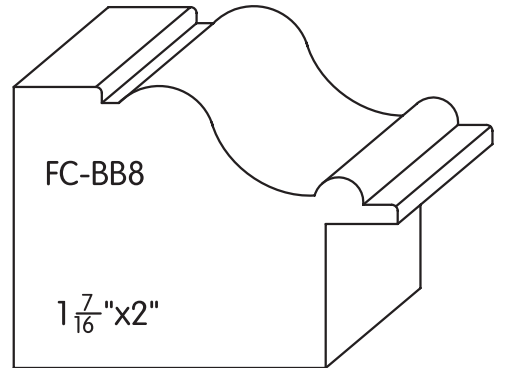
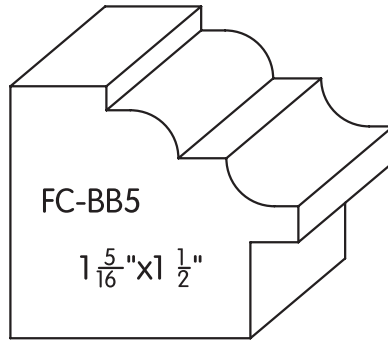
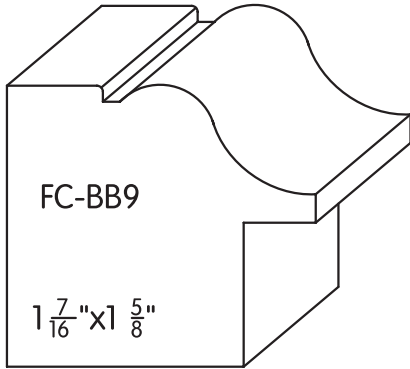
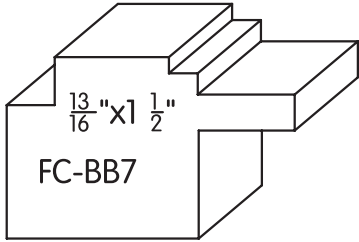
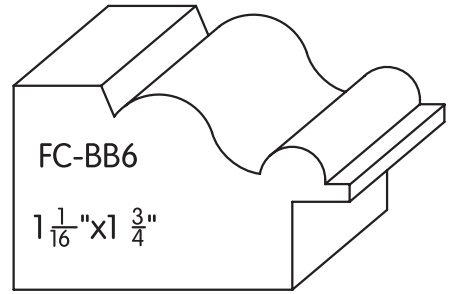
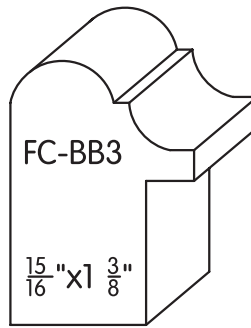
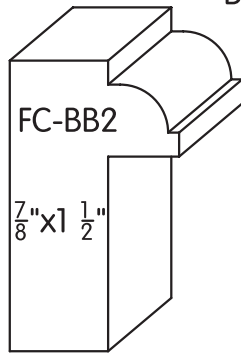
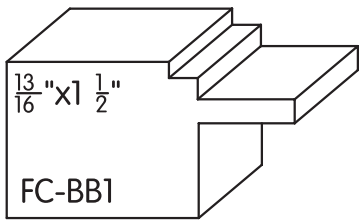

PICTURE MOLDING

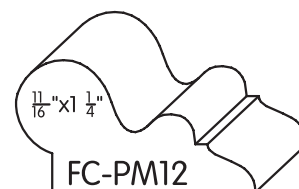
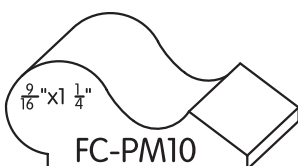
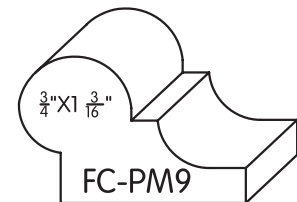
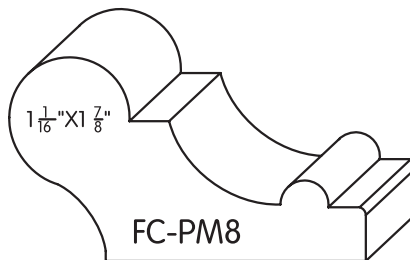
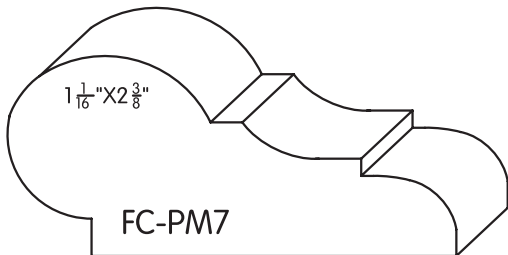
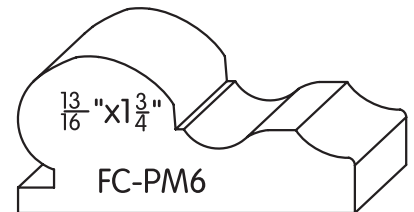
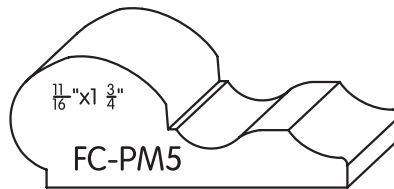
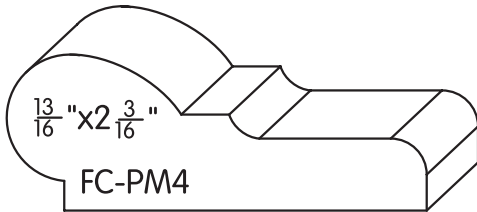
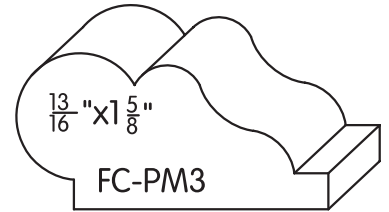
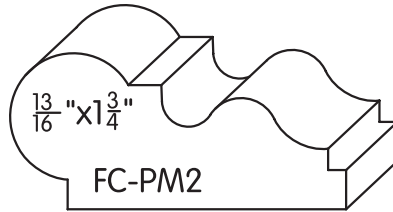
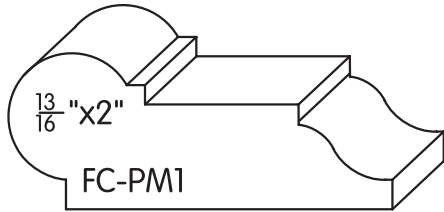

PANEL MOLDING

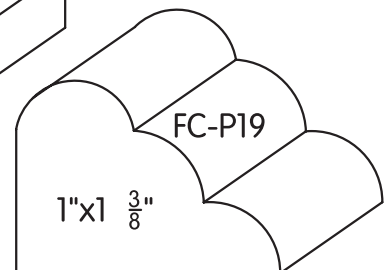
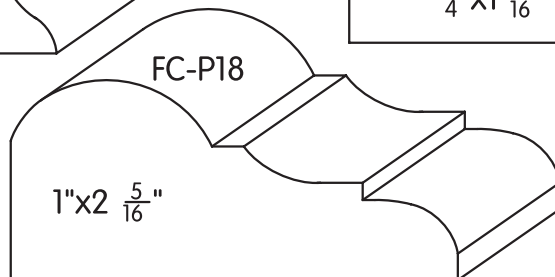
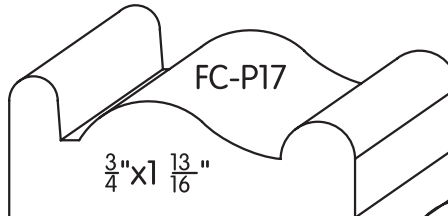
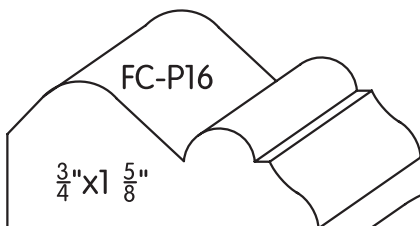
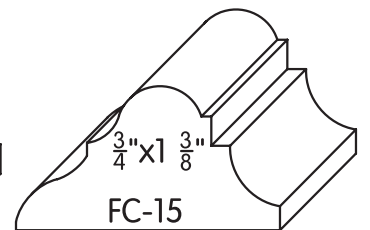
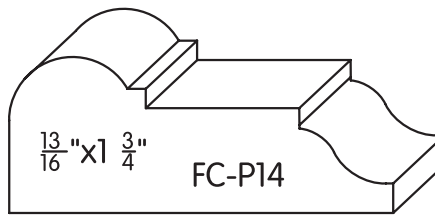
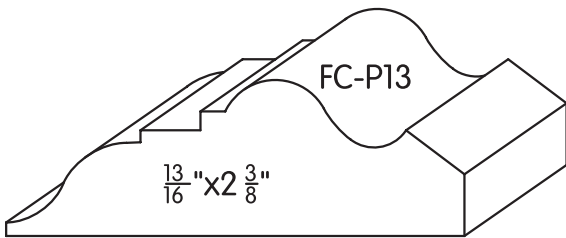
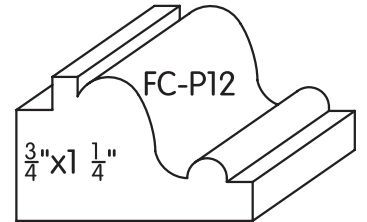
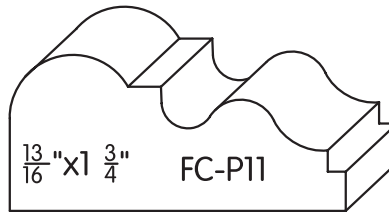
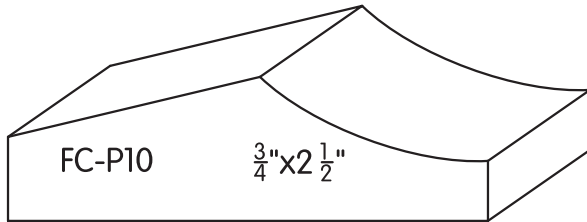
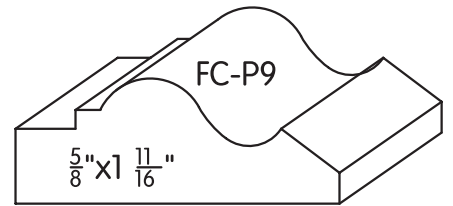
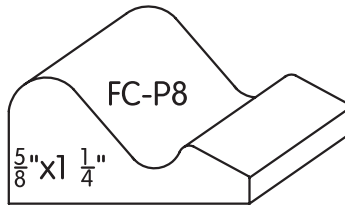
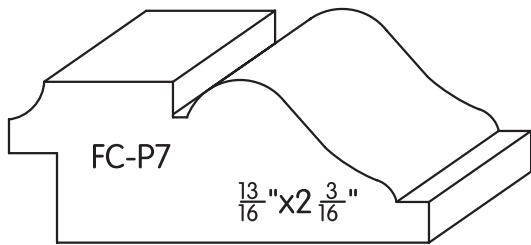
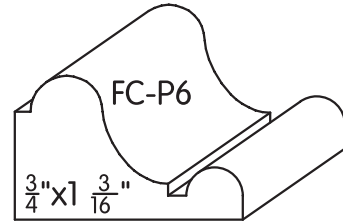
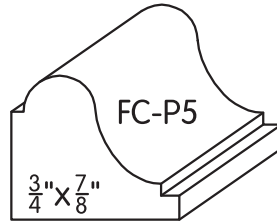
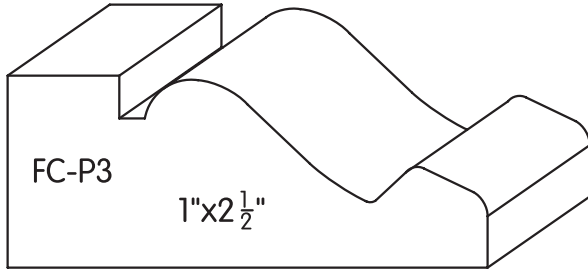
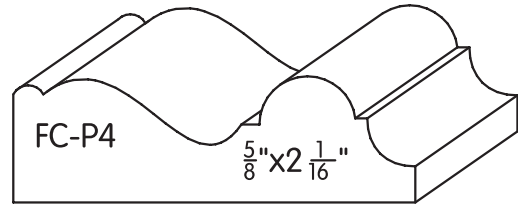
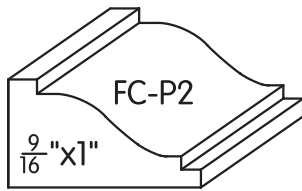
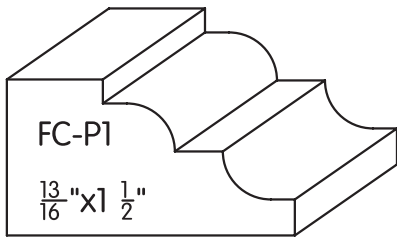

PANEL MOLDING

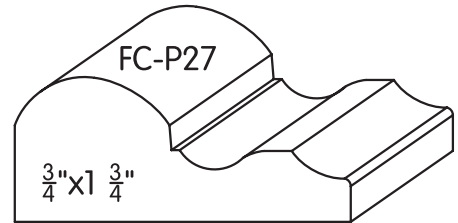
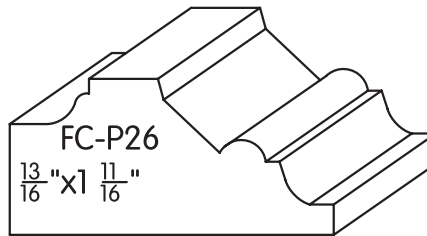
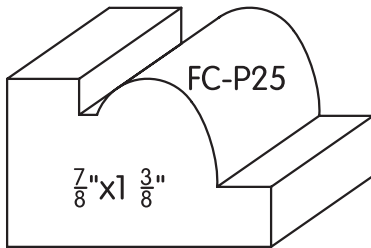
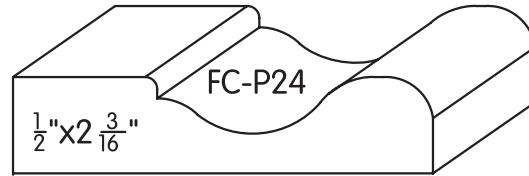
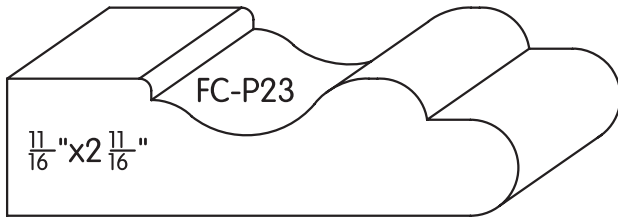
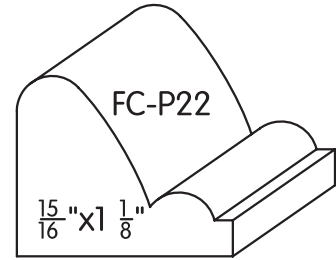
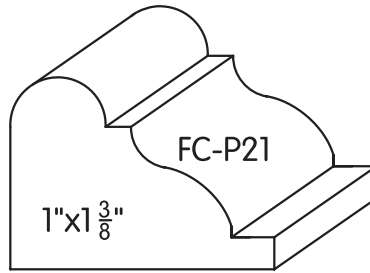
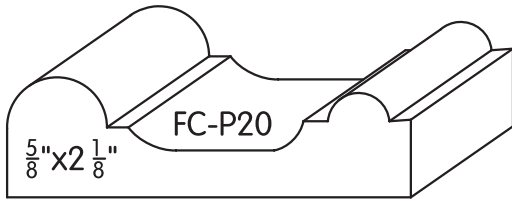

FULL ROUND

Available from $\frac{1}{2}$ " to $2\frac{3}{4}$ " Diameter in $\frac{1}{4}$ " increments

- FC-R-.5"
- FC-R-.75"
- FC-R-1"
- FC-R-1.25"
- FC-R-1.5"
- FC-R-1.75"
- FC-R-2"
- FC-R-2.25"
- FC-R-2.5"
- FC-R-2.75"

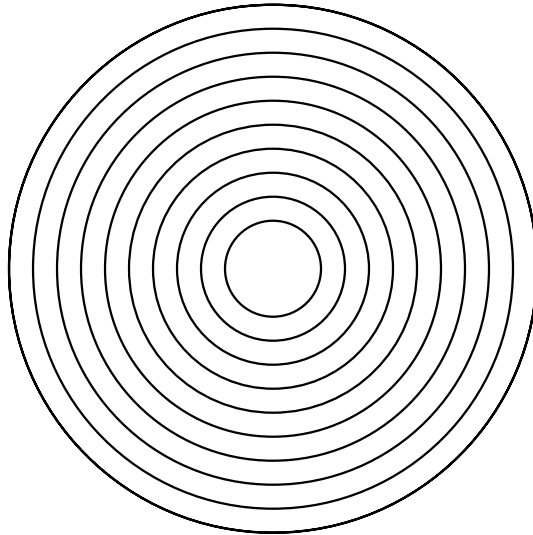

HALF ROUND

Available from $\frac{1}{2}$ " to $2\frac{3}{4}$ " Diameter in $\frac{1}{4}$ " increments

- FC-HR-.5"
- FC-HR-.75"
- FC-HR-1"
- FC-HR-1.25"
- FC-HR-1.5"
- FC-HR-1.75"
- FC-HR-2"
- FC-HR-2.25"
- FC-HR-2.5"
- FC-HR-2.75"

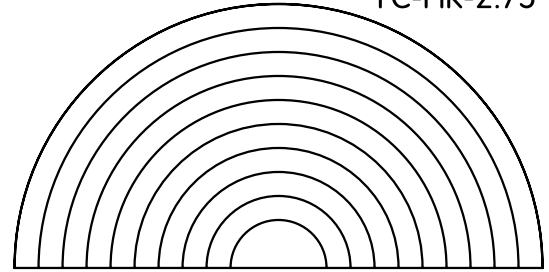

QUARTER ROUND

Available from $\frac{1}{4}$ " to $1\frac{1}{2}$ " radius in $\frac{1}{8}$ " increments

- FC-QR-.25"
- FC-QR-.375"
- FC-QR-.5"
- FC-QR-.625"
- FC-QR-.75"
- FC-QR-.875"
- FC-QR-1"
- FC-QR-1.125"
- FC-QR-1.25"
- FC-QR-1.375"
- FC-QR-1.5"

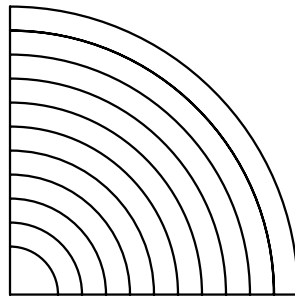

COVE MOLDING

Available from $\frac{1}{2}$ " to 2" in $\frac{1}{4}$ " increments

- FC-CO-.5"
- FC-CO-.75"
- FC-CO-1"
- FC-CO-1.25"
- FC-CO-1.5"
- FC-CO-1.75"
- FC-CO-2"

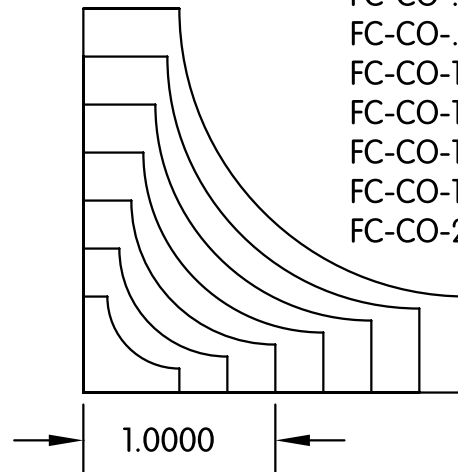

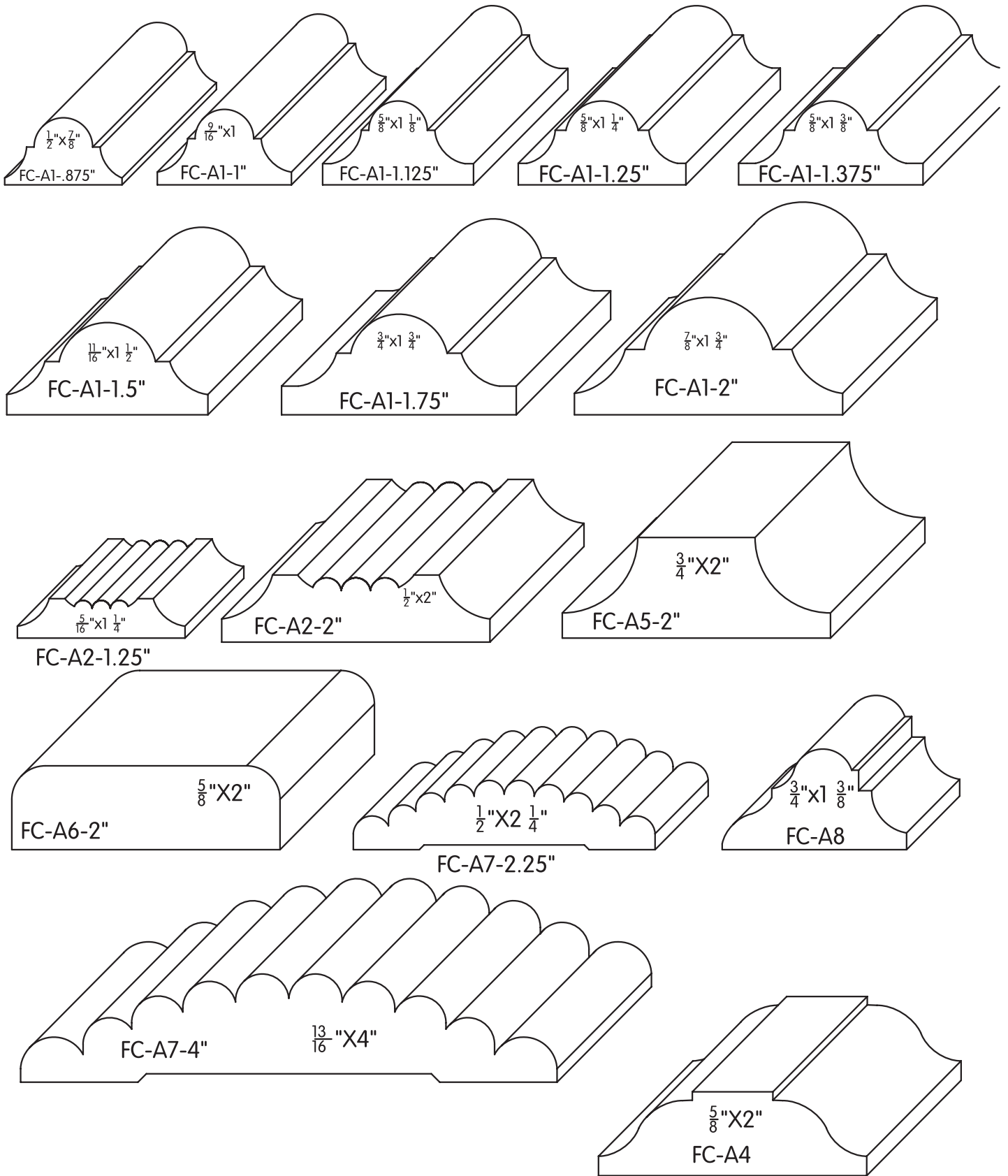

MANY PROFILES CAN BE ADJUSTED FOR WIDTH & THICKNESS.

WINDOW STOOLS & TREADS

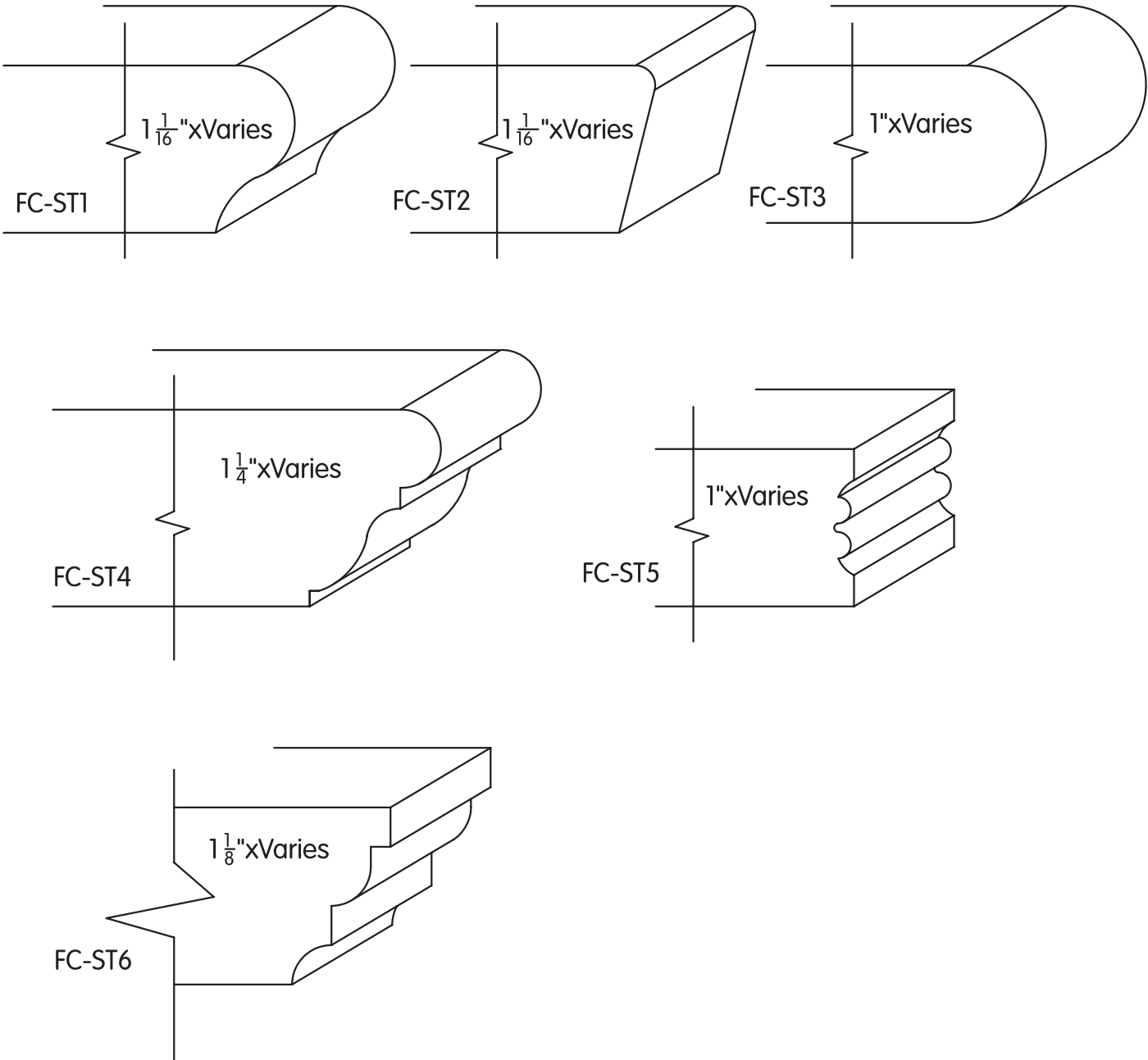

Window stools and stair treads can be made in any desired width.



$\frac{3}{4}$ " TOUNGE & GROOVE FLOORING



Available from 1" - $8\frac{1}{2}$ " wide.

$\frac{3}{4}$ " TOUNGE & GROOVE V-JOINT



Available from 1" - $8\frac{1}{2}$ " wide.

PANELING & WAINSCOTING



Available in Random widths 2" - $8\frac{1}{2}$ "
Shown as $\frac{5}{8}$ "x3"

S4S "Surfaced 4 sides" or Square Stock



S4S Stock is available from $\frac{1}{4}$ " - $3\frac{3}{4}$ " thick in
many species and up to $8\frac{1}{2}$ " wide.

ROSETTES

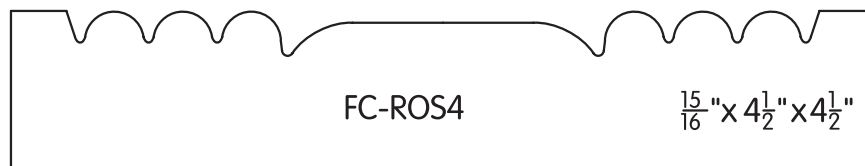
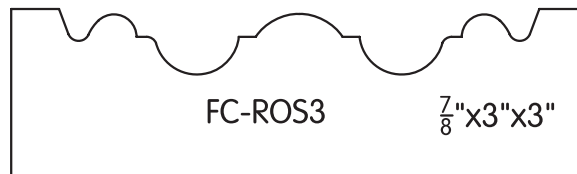
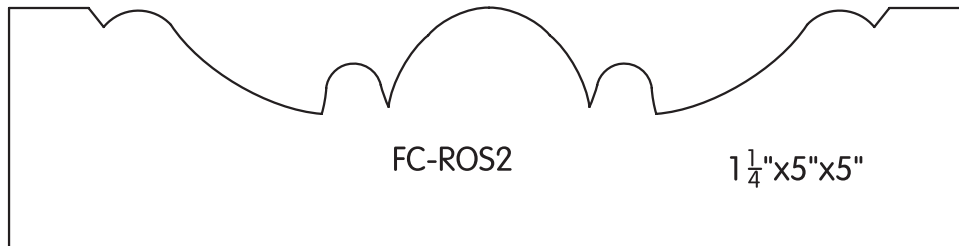
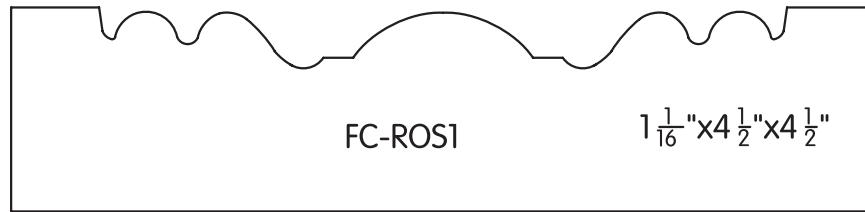

Rosettes can be made in custom sizes and thicknesses.

Custom Profiles can be made upon request.

PLINTH BLOCKS

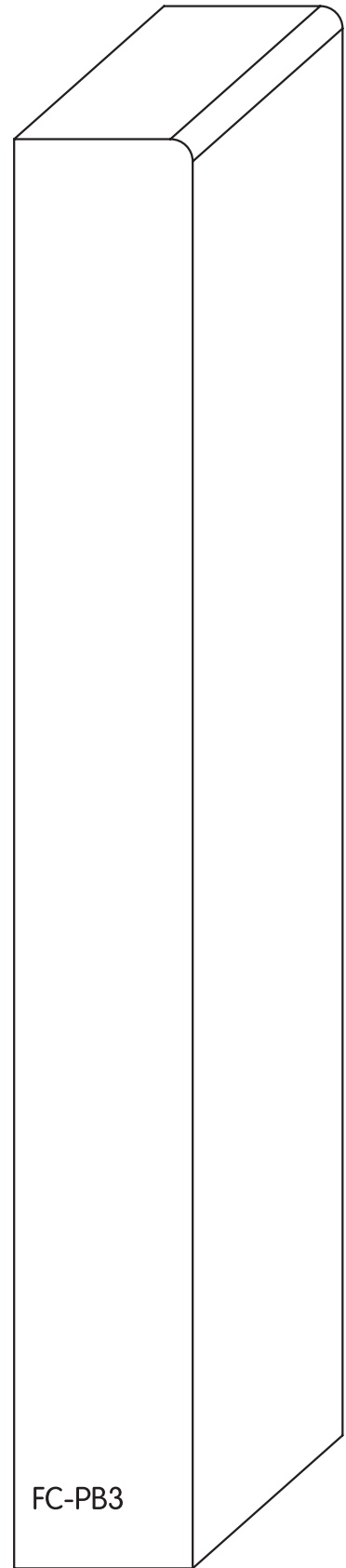
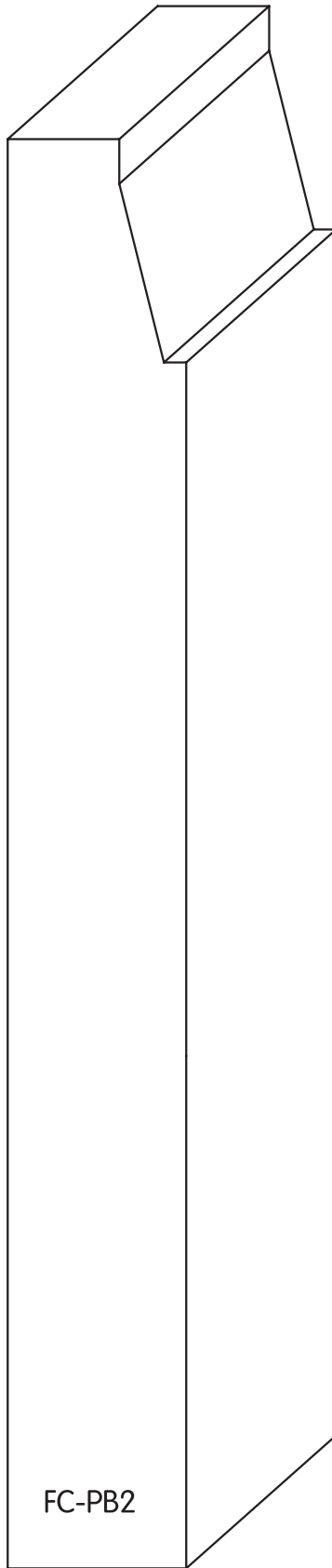
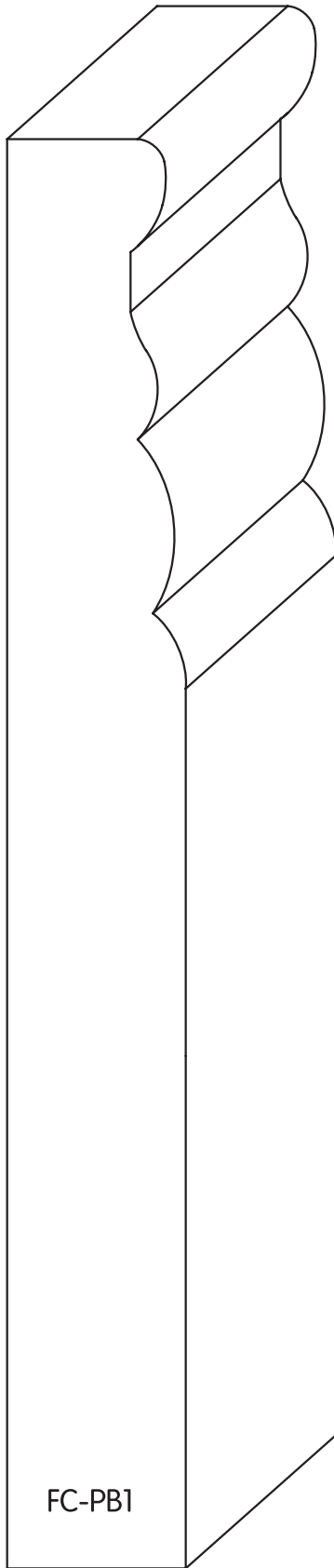

Plinth block are available in desired width, thickness & height.

Custom Profiles can be made upon request.





19c Industry St, Poughkeepsie, NY 12603
Phone (845) 485-4105 • Fax (845) 485-4106
firstcutcustomwoodworks.com